



YANDAN BAĞLAMA PABUÇLAR

SIDE CLAMPS



| Referans Nr. |  | c | L | b | n | k | k1 | k2 | L1 | d | d1 | d2 | sw | sıkma kuvveti clamping force Kgf | Tork Değeri Allowable Screw Torque (N-m) |  |
|--------------|---|---|----|----|----|----|----|----|----|-----|-----|-----|----|--|--|---|
| 2030-14 | 14 | 5 | 90 | 23 | 47 | 47 | 26 | 26 | 65 | M12 | M12 | M12 | 10 | 2000 | 35 | 3490 |
| 2030-16 | 16 | | | | | | | | | | | | | | | 3670 |
| 2030-18 | 18 | 5 | 95 | 28 | 57 | 52 | 26 | 26 | 65 | M12 | M12 | M12 | 10 | 2000 | 35 | 5000 |
| 2030-20 | 20 | | | | | | | | | | | | | | | 5355 |
| 2030-22 | 22 | | | | | | | | | | | | | | | 5720 |
| 2030-24 | 24 | | | | | | | | | | | | | | | 6190 |
| 2030-28 | 28 | | | | | | | | | | | | | | | 6650 |







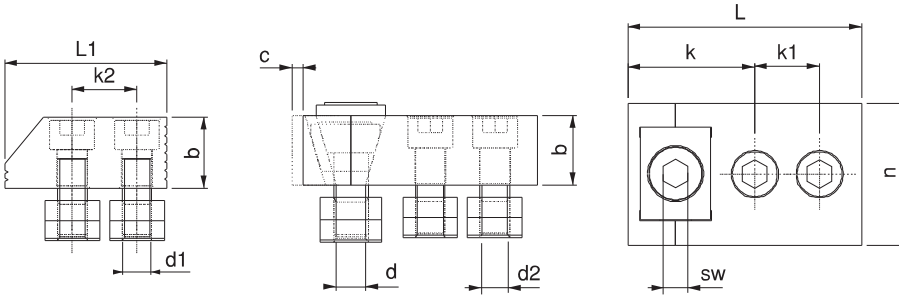

Ürün Nr. 2030 Dereceli Yandan Bağlama Set

- İş parçasını dayama yönünde sıktığında parçanın özgün yapısını değişikliğe sebep vermez
- Sertleştirilmiş
- Siyah kaplama
- Plastik kutuda set

Product Nr. 2030 Graded side Wrench Set

- When the product clamps the work piece in the direction of rest, it does not cause alteration in the genuine structure of the piece.
- Hardened
- Black coating
- Set is in the plastic box



| Set İçindekiler / The set consists of | | | | | | |
|---------------------------------------|---|---|---|---|---|---|
| Parça Part |  |  |  |  |  |  |
| Adet Quantity | 2 | 2 | 10 | 10 | 1 | 1 |

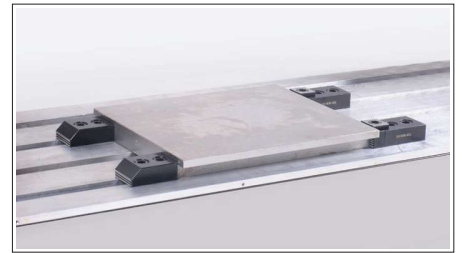

| Referans Nr. |  |
|--------------|---|
| 2035-14 | 14 |
| 2035-16 | 16 |
| 2035-18 | 18 |
| 2035-20 | 20 |
| 2035-22 | 22 |
| 2035-24 | 24 |
| 2035-28 | 28 |

Dereceli Yandan Bağlama Gövde





| Referans Nr. |  |
|--------------|---|
| 2040-14 | 14 |
| 2040-16 | 16 |
| 2040-18 | 18 |
| 2040-20 | 20 |
| 2040-22 | 22 |
| 2040-24 | 24 |
| 2040-28 | 28 |

Dereceli Yandan Bağlama Dayama



Not: Sabit dayamanın dereceli tarafı ince parçalar, düz tarafı ise kalın parçalarda kullanılmak üzere iki farklı şekilde kullanılabilir.

Note: Fixed rest can be used as two different ways: Graded side is used for thin pieces and the Straight side is used with thick pieces.

| Referans Nr. |  | c | L | L1 | L2 | L3 | b | b1 ±0.01 | n | k | k1 | k2 | d | d1 | d2 | sw | sıkma kuvveti clamping force Kgf | Tork Değeri Allowable Screw Torque (N-m) |  |
|--------------|---|-------|-----|----|----|----|----|-------------|----|----|----|----|-----|-----|-----|----|--|--|---|
| 2050-14 | 14 | 5 | 110 | 90 | 85 | 65 | 41 | 18 | 47 | 47 | 26 | 26 | M12 | M12 | M12 | 6 | 1000 | 15 | 5920 |
| 2050-16 | 16 | | | | | | | | | | | | | | | | | | 6210 |
| 2050-18 | 18 | | | | | | | | | | | | | | | | | | 8090 |
| 2050-20 | 20 | | | | | | | | | | | | | | | | | | 8440 |
| 2050-22 | 22 | | | | | | | | | | | | | | | | | | 8825 |
| 2050-24 | 24 | | | | | | | | | | | | | | | | | | 10080 |
| 2050-28 | 28 | 10750 | | | | | | | | | | | | | | | | | |







Ürün Nr. 2050 Dereceli Yandan Bağlama (Paralelli) Set

- İş parçasını dayama yönünde sıkıldığında parçanın özgün yapısını değişikliğe sebep vermez. Paralelli oluşundan dolayı işlenen parçaya delik işlemi uygulanabilir.
- Sertleştirilmiş
- Siyah kaplama
- Plastik kutuda set

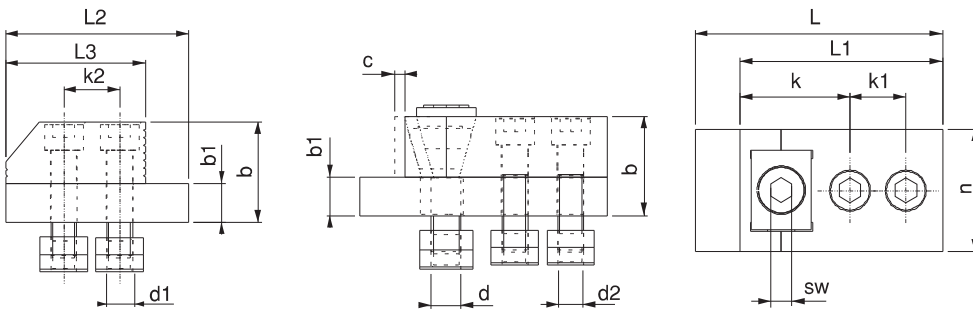
Product Nr. 2050 Graded side Wrench Set (With Parallel)

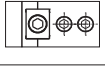
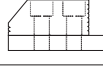
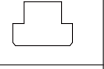
- When the product clamps the work piece in the direction of rest, it does not cause alteration in the genuine structure of the piece. Because of being with parallel, hole process can be applied on the machined piece.
- Hardened
- Black coating
- Set is in the plastic box



| Set İçindekiler / The set consists of | | | | | | |
|---------------------------------------|---|---|---|---|---|--|
| Parça Part |  |  |  |  |  |  |
| Adet Quantity | 2 | 2 | 10 | 10 | 2 | 1 |

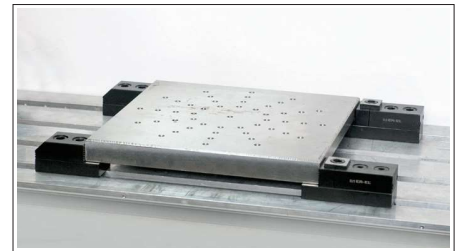

Dereceli Yandan Bağlama (Paralelli) Gövde

| Referans Nr. |  |
|--------------|---|
| 2055-14 | 14 |
| 2055-16 | 16 |
| 2055-18 | 18 |
| 2055-20 | 20 |
| 2055-22 | 22 |
| 2055-24 | 24 |
| 2055-28 | 28 |



Dereceli Yandan Bağlama (Paralelli) Dayama

| Referans Nr. |  |
|--------------|---|
| 2060-14 | 14 |
| 2060-16 | 16 |
| 2060-18 | 18 |
| 2060-20 | 20 |
| 2060-22 | 22 |
| 2060-24 | 24 |
| 2060-28 | 28 |

Not: Sabit dayamanın dereceli tarafı ince parçalar, düz tarafı ise kalın parçalarda kullanılmak üzere iki farklı şekilde kullanılabilir.

Note: Fixed rest can be used as two different ways: Graded side is used for thin pieces and the Straight side is used with thick pieces.



| Referans Nr. | | c | L | b | b1 | n | n1 | n2 | k | k1 | k2 | sw | l | h | h1 | d | d1 | sıkma kuvveti clamping force Kgf | Tork Değerleri Allowable Screw Torque (N-m) | |
|--------------|----|----|-----|----|----|----|------|------|----|----|----|----|----|----|----|-----|-----|--|--|------|
| 2070-14 | 14 | 10 | 142 | 24 | 8 | 37 | 12.5 | 18.5 | 65 | 54 | 26 | 6 | 65 | 23 | 10 | M12 | M12 | 850 | 15 | 3575 |
| 2070-16 | 16 | | | | | | | | | | | | | | | | | | | 3710 |
| 2070-18 | 18 | 14 | 145 | 28 | 10 | 48 | 12.5 | 18.5 | 74 | 56 | 26 | 8 | 65 | 28 | 11 | M12 | M12 | 1000 | 35 | 5215 |
| 2070-20 | 20 | | | | | | | | | | | | | | | | | | | 5400 |
| 2070-22 | 22 | | | | | | | | | | | | | | | | | | | 5610 |

Ürün Nr. 2070 Kızaklı Yandan Bağlama Set

- Hareketli çenenin kızaklı yapısından dolayı iş parçasını dayama ve pleyt yönüne sıkar. Çenenin geniş hareketi iş parçasını bağlama ve sökmede kolaylık sağlar.
- DIN 650 T-Kanala uyumludur
- Çene Sertlik : Sertleştirilmiş
- Siyah kaplama
- Plastik kutuda set

Product Nr. 2070 Sliding Side Wrench Set

- Because of the sliding structure of the moving jaw it clamps the work piece in the direction of resting and plate. Wide movement of the jaw provides convenience in coupling and dismantling of the workpiece.
- It is in compliance with DIN 650 T-Slot
- Hardness of jaw: Hardened
- Black coating
- Set is in the plastic box

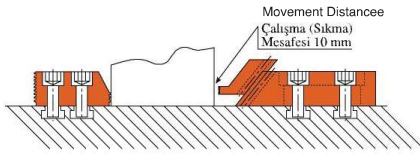
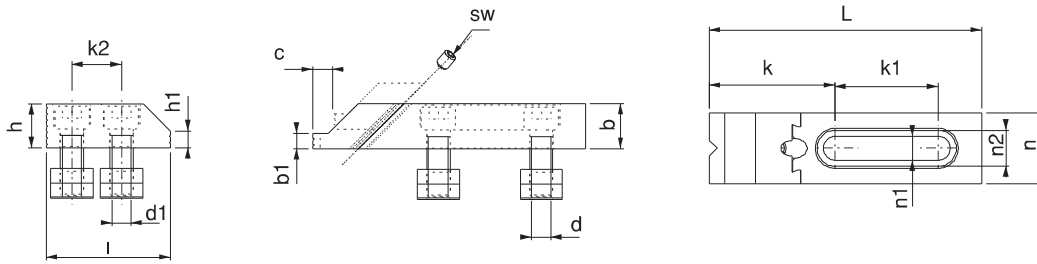

Not: Sabit dayamanın dereceli tarafı ince parçalar, düz tarafı ise kalın parçalarda kullanılmak üzere iki farklı şekilde kullanılabilir.
Note: Fixed rest can be used as two different ways: Graded side is used for thin pieces and the Straight side is used with thick pieces.



| Set İçindekiler / The set consists of | | | | | | |
|---------------------------------------|---|---|---|---|---|---|
| Parça Part | | | | | | |
| Adet Quantity | 2 | 2 | 8 | 8 | 2 | 1 |

| Referans Nr. | |
|--------------|----|
| 2075-14 | 14 |
| 2075-16 | 16 |
| 2075-18 | 18 |
| 2075-20 | 20 |
| 2075-22 | 22 |
| 2075-24 | 24 |
| 2075-28 | 28 |

Kızaklı Yandan Bağlama Gövde

Sliding Side Wrench Body



| Referans Nr. | |
|--------------|----|
| 2040-14 | 14 |
| 2040-16 | 16 |
| 2040-18 | 18 |
| 2040-20 | 20 |
| 2040-22 | 22 |
| 2040-24 | 24 |
| 2040-28 | 28 |



Kızaklı Yandan Bağlama Dayama

Sliding Side Wrench Pluggable



MIKSAN® bir ER-EL markasıdır.

Side Wrench Set

| Referans Nr. |  | Sıkma Kuvveti Clamping Force |  |
|----------------|---|---------------------------------|---|
| 2070-MBS701214 | 14 | 2500 | 3.14 |
| 2070-MBS701216 | 16 | 2500 | 3.14 |
| 2070-MBS701218 | 18 | 2500 | 3.14 |
| 2070-MBS701220 | 20 | 2500 | 3.14 |



Ürün Nr. 2070 Yandan Bağlama Set

- Mafsallı tasarımıyla düz olmayan yüzeylerde dahi mevcut yüzey şeklini alarak emniyetli bağlama yapar.

Product Nr. 2070 Side Wrench Set

- With its articulated design, it makes safe bonding even on uneven surfaces by taking the existing surface shape.

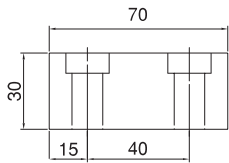

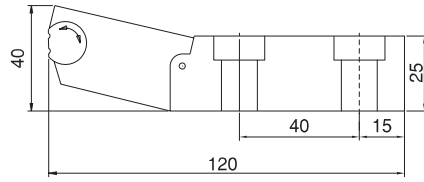

Genişlik / Width 40 mm.



Genişlik / Width 40 mm.



| Referans Nr. |  |  |
|---------------|---|---|
| 2070-MS701114 | 14 | 0.87 |
| 2070-MS701116 | 16 | 0.87 |
| 2070-MS701118 | 18 | 0.87 |
| 2070-MS701120 | 20 | 0.87 |

Ürün Nr. 2070 Yandan Bağlama Gövde

- Mafsallı tasarımıyla düz olmayan yüzeylerde dahi mevcut yüzey şeklini alarak emniyetli bağlama yapar.



Product Nr. 2070 Side Press Body

- With its articulated design, it makes safe bonding even on uneven surfaces by taking the existing surface shape.

Yandan Bağlama Gövde

Side Press Body



| Referans Nr. |  |  |
|---------------|---|---|
| 2070-MD702114 | 14 | 0.65 |
| 2070-MD702116 | 16 | 0.65 |
| 2070-MD702118 | 18 | 0.65 |
| 2070-MD702120 | 20 | 0.65 |



Ürün Nr. 2070 Yandan Bağlama Dayama

Product Nr. 2070 Side Press Stopper

Yandan Bağlama Dayama

Side Press Stopper



| Referans Nr. |  | Sıkma Kuvveti Clamping Force |  |
|----------------|---|---------------------------------|---|
| 2070-MBS801114 | 14 | 2500 | 6.15 |
| 2070-MBS801116 | 16 | 2500 | 6.15 |
| 2070-MBS801118 | 18 | 2500 | 6.15 |
| 2070-MBS801120 | 20 | 2500 | 6.15 |

Ürün Nr. 2070 Yandan Bağlama (Paralelli) Set

- Mafsallı tasarımıyla düz olmayan yüzeylerde dahi mevcut yüzey şeklini alarak emniyetli bağlama yapar.

Product Nr. 2070 Side Wrench Set (With Parallel)

- With its articulated design, it makes safe bonding even on uneven surfaces by taking the existing surface shape.

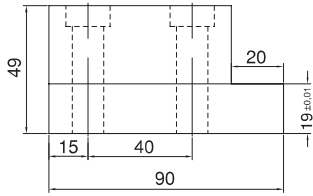

Genişlik / Width 40 mm.

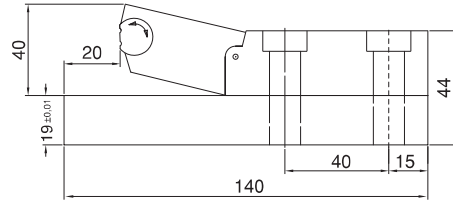



Genişlik / Width 40 mm.

Yandan Bağlama (Paralelli) Set

Side Wrench Set (With Parallel)



| Referans Nr. |  |  |
|---------------|---|---|
| 2070-MS801214 | 14 | 1.86 |
| 2070-MS801216 | 16 | 1.86 |
| 2070-MS801218 | 18 | 1.86 |
| 2070-MS801220 | 20 | 1.86 |

Ürün Nr. 2070 Yandan Bağlama Gövde

- Mafsallı tasarımıyla düz olmayan yüzeylerde dahi mevcut yüzey şeklini alarak emniyetli bağlama yapar.



Product Nr. 2070 Side Press Body

- With its articulated design, it makes safe bonding even on uneven surfaces by taking the existing surface shape.

Yandan Bağlama Gövde

Side Press Body



| Referans Nr. |  |  |
|---------------|---|---|
| 2070-MD802214 | 14 | 1.18 |
| 2070-MD802216 | 16 | 1.18 |
| 2070-MD802218 | 18 | 1.18 |
| 2070-MD802220 | 20 | 1.18 |

Ürün Nr. 2070 Yandan Bağlama Dayama

Product Nr. 2070 Side Press Stopper

Yandan Bağlama Dayama

Side Press Stopper



| Referans Nr. | A | B | C | D | E | F | G | H | J | K | L | M | Sıkma Kuvveti Clamping Force Kgf | Tork Değeri Allowable Screw Torque (N-m) |  |
|--------------|------|-----|-----|----|----|----|----|-----|----|---|-----|----|----------------------------------|--|---|
| 2072-08016 | 39.5 | 65 | 7.5 | 25 | 45 | 16 | 7 | 1.5 | 7 | 4 | M8 | 25 | 400 | 8 | 160 |
| 2072-12022 | 60 | 85 | 10 | 40 | 60 | 22 | 12 | 2 | 9 | 6 | M12 | 35 | 900 | 26 | 450 |
| 2072-16030 | 77 | 100 | 14 | 50 | 70 | 30 | 14 | 2 | 13 | 8 | M16 | 40 | 1700 | 60 | 900 |

Ürün Nr. 2072 Yandan Bağlama

- Siyah Kaplama

Product Nr. 2072 Side Clamps

- Black Coating

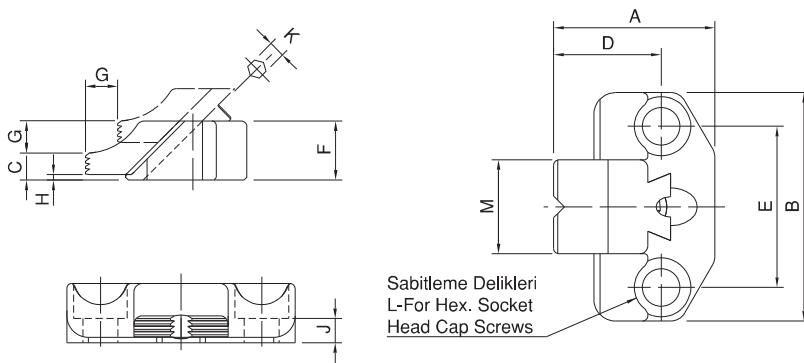

Yandan Bağlama

Side Clamps

| Referans Nr. | A | B | C | D | E | F | G | H | J | K | L | M | Sıkma Kuvveti Clamping Force Kgf | Tork Değeri Allowable Screw Torque (N-m) |  |
|--------------|------|-----|------|----|----|----|----|-----|----|---|-----|----|----------------------------------|--|---|
| 2073-08016 | 39.5 | 65 | 19.5 | 25 | 45 | 16 | 7 | 1.5 | 7 | 4 | M8 | 25 | 400 | 8 | 180 |
| 2073-12022 | 60 | 85 | 29 | 40 | 60 | 22 | 12 | 2 | 9 | 6 | M12 | 35 | 900 | 26 | 500 |
| 2073-16030 | 77 | 100 | 38 | 50 | 70 | 30 | 14 | 2 | 13 | 8 | M16 | 40 | 1700 | 60 | 1010 |

Ürün Nr. 2073 Yandan Bağlama

- Çene Sertlik: Sertleştirilmiş
- Siyah Kaplama

Product Nr. 2073 Side Clamps

- Hardness of jaw: Hardened
- Black Coating

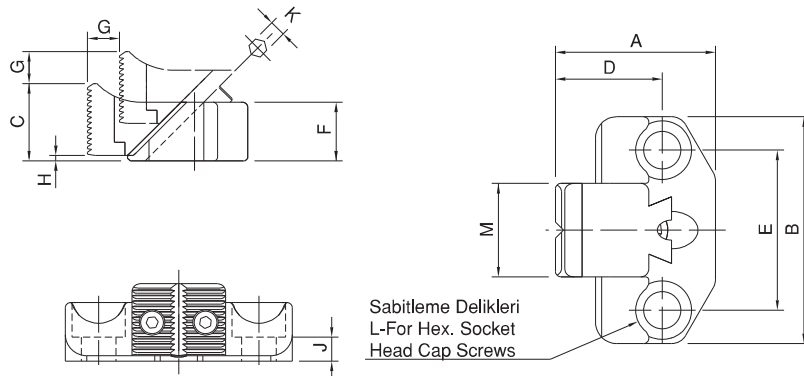

| Referans Nr. | A | B | C | D | E | F | G | H | J | K | L | M | N |
|--------------|----|----|----|----|------|-----|------|----|----|----|----|----|----------|
| 2077-08001 | 44 | 32 | 20 | 8 | 28,5 | 4 | 26,5 | 23 | 7 | 15 | 19 | 10 | M8x1,25 |
| 2077-10001 | 54 | 40 | 25 | 10 | 35 | 5 | 33 | 29 | 9 | 16 | 24 | 12 | M10x1,5 |
| 2077-12001 | 62 | 46 | 30 | 12 | 39,5 | 5,5 | 37,5 | 35 | 11 | 17 | 27 | 14 | M12x1,75 |

| Referans Nr. | P | Sıkma Kuvveti Clamping Force Kgf | Tork Değeri Allowable Screw Torque (N-m) |  (g) |
|--------------|----|--|--|--|
| 2077-08001 | 6 | 350 | 45 | 160 |
| 2077-10001 | 8 | 550 | 55 | 310 |
| 2077-12001 | 10 | 700 | 70 | 490 |



Ürün Nr. 2077 Yandan Bağlama

- Siyah Kaplama

Product Nr. 2077 Side Clamps

- Black Coating

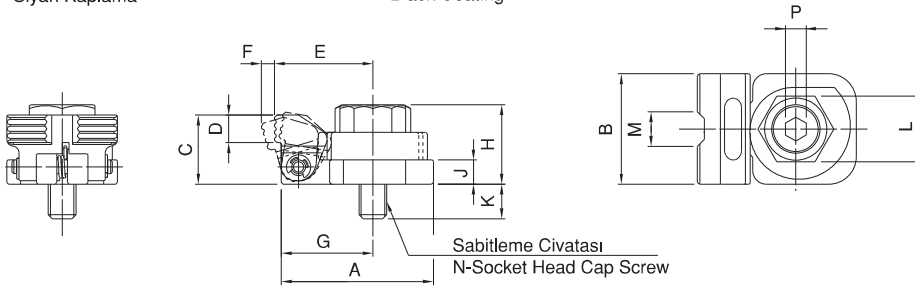

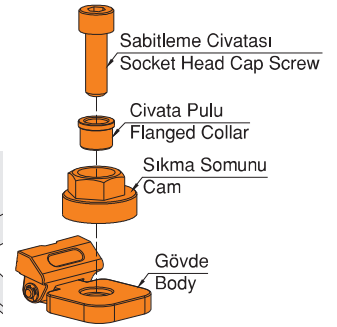
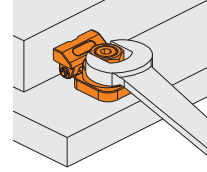

Kullanım Şekli / How To Use

- Önce parçayı sabitleyip sonra anahtar ile sıkma işlemi yapılır.
- Secure the body and the flanged collar with a socket head cap screw, and then turn the the cam with a wrench to clamp a workpiece.



Yandan Bağlama

Side Clamps

| Referans Nr. |  | A | H | L | S | Sıkma Kuvveti Clamping Force Kgf |  (g) |
|--------------|---|----|----|-----|---|--|--|
| 2080-014 | 14 | 61 | 57 | 108 | 5 | 1500 | 1850 |
| 2080-016 | 16 | 61 | 57 | 108 | 5 | 1500 | 1850 |
| 2080-018 | 18 | 61 | 57 | 108 | 5 | 1500 | 1850 |
| 2080-020 | 20 | 61 | 57 | 108 | 5 | 1500 | 1850 |
| 2080-022 | 22 | 61 | 57 | 108 | 5 | 1500 | 1850 |
| 2080-024 | 24 | 61 | 57 | 108 | 5 | 1500 | 1850 |
| 2080-028 | 28 | 61 | 57 | 108 | 5 | 1500 | 1850 |



Ürün Nr. 2080 Yandan Bağlama

- Vida kaldırması ile dikey ve yatay sıkma kuvveti sağlamakta.

Gövde

- Statik Boya
- Çene
- Sertleştirilmiş



Product Nr. 2080 Side Clamps

- Vertical down thrust and horizontal clamping force available simultaneously with the operation of leverage screw

Body

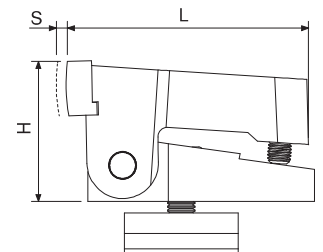
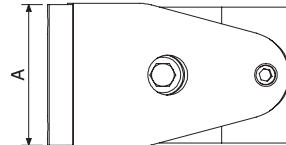
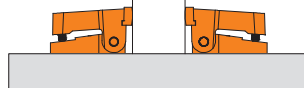
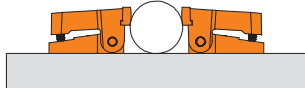
- Statical Painting
- Jaw
- Hardened



| Referans Nr. |  | c | b | k1 | k2 | k3 | k4 | L | h | h1 | d | d1 | sıkma kuvveti clamping force Kgf |  (g) |
|--------------|---|-----|----|----|----|----|----|----|----|----|-----|-----|--|--|
| 2090-14 | 14 | 3.5 | 30 | 95 | 99 | 26 | 26 | 65 | 28 | 10 | M12 | M12 | 3500 | 7925 |
| 2090-16 | 16 | | | | | | | | | | | | | 8490 |
| 2090-18 | 18 | | | | | | | | | | | | | 4610 |
| 2090-20 | 20 | | | | | | | | | | | | | 8850 |
| 2090-22 | 22 | | | | | | | | | | | | | 9030 |
| 2090-24 | 24 | | | | | | | | | | | | | 9490 |
| 2090-28 | 28 | | | | | | | | | | | | | 9800 |







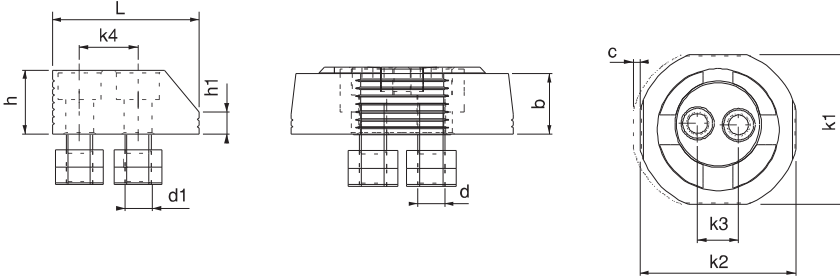

Ürün Nr. 2090 Kollu Yandan Bağlama Set

- Ürünün eksantrik çalışma sistemi saat yönünde sıkıldığında iş parçasını dayama ve pleyt yönüne özel dizayn anahtarları ile yüksek kuvvette sıkar.
- 1-Kollu yandan sıkma pabucunun eksantrik hareketi 3.5 mm'dir.
- 2-Ürün iş parçasına 1.5 - 2 mm yakınlaştırılır.
- 3-10 mm alyan ile imbus civataları sabitlenir.
- 4-Ürünü anahtarları ile saat yönünde çevirerek iş parçasını sabitleme işlemi gerçekleştirilir.
- DIN 650 T-Kanala uyumludur
- Somun Sertlik : Sertleştirilmiş
- Siyah kaplama
- Plastik kutuda set

Product Nr. 2090 Armed Side Press Set

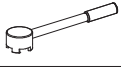
- When the eccentric working system of the product is tightened clockwise, it clamps the work piece with high force in the direction of resting and plate with it's special designed wrench.
- 1-Eccentric movement of Armed Side Clamp 3.5 mm.
- 2-It brings the product 1.5 - 2mm close to the work piece
- 3-imbus bolts are fixed with 10mm allen.
- 4-Fixing of the work piece is implemented by turning the product clockwise with the wrench.
- It is in compliance with DIN 650 T-Slot
- Hardness of nut: Hardened
- Black coating
- Set is in the plastic box



| Set İçindekiler / The set consists of | | | | | | | |
|---------------------------------------|---|---|---|---|---|---|---|
| Parça Part |  |  |  |  |  |  |  |
| Adet Quantity | 2 | 2 | 1 | 8 | 8 | 1 | 1 |

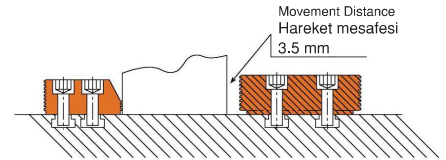

Not: Sabit dayamanın dereceli tarafı ince parçalar, düz tarafı ise kalın parçalarda kullanılmak üzere iki farklı şekilde kullanılabilir.
Note: Fixed rest can be used as two different ways: Graded side is used for thin pieces and the Straight side is used with thick pieces.

| Referans Nr. |  |
|--------------|---|
| 2090-114 | 14 |
| 2090-116 | 16 |
| 2090-118 | 18 |
| 2090-120 | 20 |
| 2090-122 | 22 |
| 2090-124 | 24 |
| 2090-128 | 28 |

Kollu Yandan Bağlama Gövde

Armed Side Press Body





| Referans Nr. |  |
|--------------|---|
| 2040-14 | 14 |
| 2040-16 | 16 |
| 2040-18 | 18 |
| 2040-20 | 20 |
| 2040-22 | 22 |
| 2040-24 | 24 |
| 2040-28 | 28 |

Not: Sabit dayamanın dereceli tarafı ince parçalar, düz tarafı ise kalın parçalarda kullanılmak üzere iki farklı şekilde kullanılabilir.
Note: Fixed rest can be used as two different ways: Graded side is used for thin pieces and the Straight side is used with thick pieces.

Kollu Yandan Bağlama Dayama

Armed Side Press Pluggable



| Referans Nr. |  | a1 | a2 | b | b1 | c | h min-max | L | sw | F1 Sıkma kuvveti Clamping force Kgf | F2 Sıkma kuvveti Clamping force Kgf |  (kg) |
|--------------|---|----|----|----|----|----|--------------|-----|----|--|--|---|
| 2095-571 | 14-16-18 | 37 | 37 | 57 | 19 | 8 | 78-98 | 185 | 10 | 2250 | 350 | 3.68 |
| 2095-761 | 20-22-24-28 | 37 | 45 | 76 | 26 | 11 | 98-118 | 240 | 14 | 3000 | 450 | 7.66 |

Ürün Nr. 2095 Blok Yandan Bağlama



- İş parçasını dayama ve pleyt yönüne sıkarak özellikle yüksek iş parçaları için tasarlanmıştır
- Çene Sertlik: Sertleştirilmiş
- Siyah kaplama

Product Nr. 2095 Block Side Press

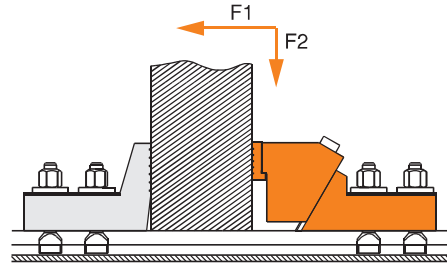
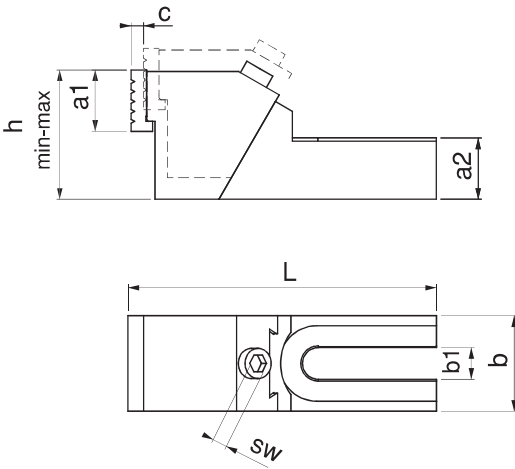
- It clamps the workpieces in clamp rest direction and plate direction, it is designed especially for high workpieces.
- Hardness of jaw: Hardened
- Black coating



Blok Yandan Bağlama

| Referans Nr. |  | a1 | a2 | b | b1 | c | h min-max | L | sw | F1 Sıkma kuvveti Clamping force Kgf | F2 Sıkma kuvveti Clamping force Kgf |  (kg) |
|--------------|---|----|----|----|----|----|--------------|-----|----|--|--|---|
| 2095-572 | 14-16-18 | 37 | 37 | 57 | 19 | 8 | 78-98 | 185 | 10 | 2250 | 350 | 3.6 |
| 2095-762 | 20-22-24-28 | 37 | 45 | 76 | 26 | 11 | 98-118 | 240 | 14 | 3000 | 450 | 6.7 |



Ürün Nr. 2095 Blok Yandan Bağlama

- İş parçasını dayama ve pleyt yönüne sıkarak büyük plakaların bağlanabilmesi için tasarlanmıştır
- Çene Sertlik: Sertleştirilmiş
- Siyah kaplama

Product Nr. 2095 Block Side Press

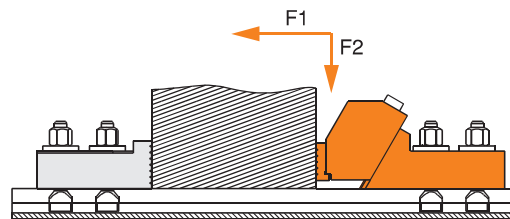
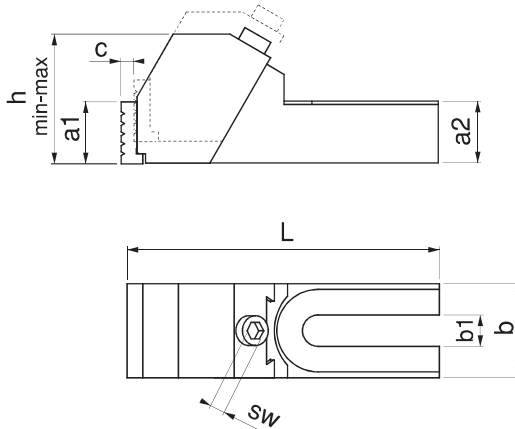
- It clamps the workpieces in clamp rest direction and plate direction, it is designed for clamping big plates.
- Hardness of jaw: Hardened
- Black coating



| Referans Nr. |  | a2 | b | b1 | h | L |  (kg) |
|--------------|---|----|----|----|-----|-----|---|
| 2098-571 | 14-16-18 | 37 | 57 | 19 | 85 | 124 | 2.025 |
| 2098-761 | 20-22-24-28 | 45 | 76 | 26 | 105 | 154 | 4.185 |



Ürün Nr. 2098 Blok Yandan Bağlama Dayaması



- 2095-571 ve 761 pabuçlar için dayama olarak tasarlanmıştır.
- Siyah kaplama

Product Nr. 2098 Block Stopper Side Press

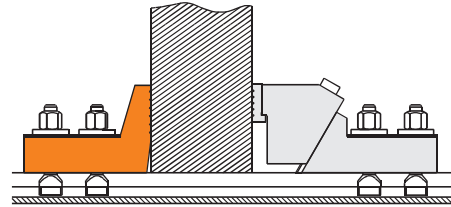
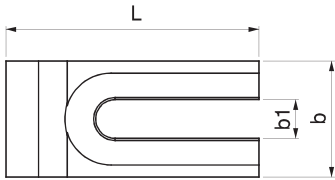
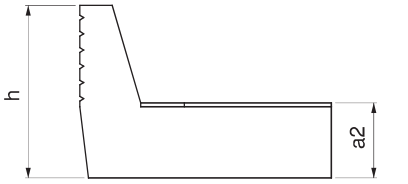
- It is designed as clamp rest for clamps 2095-571 and 761.
- Black coating



Blok Yandan Bağlama Dayaması

| Referans Nr. |  | a2 | b | b1 | h | L |  (kg) |
|--------------|---|----|----|----|----|-----|---|
| 2098-572 | 14-16-18 | 37 | 57 | 19 | 47 | 112 | 2.800 |
| 2098-762 | 20-22-24-28 | 45 | 76 | 26 | 49 | 140 | 4.185 |



Ürün Nr. 2098 Blok Yandan Bağlama Dayaması

- 2095-572 ve 762 pabuçlar için dayama olarak tasarlanmıştır.
- Siyah kaplama

Product Nr. 2098 Block Stopper Side Press

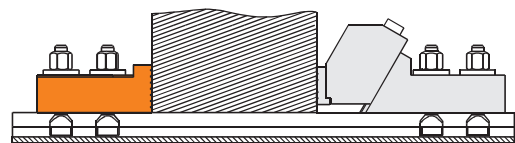
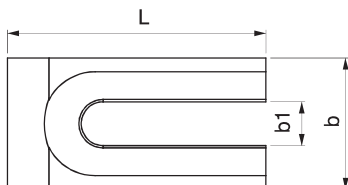
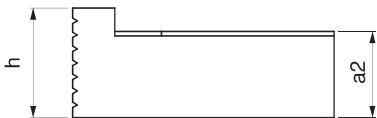
- It is designed as clamp rest for clamps 2095-572 and 762.
- Black coating



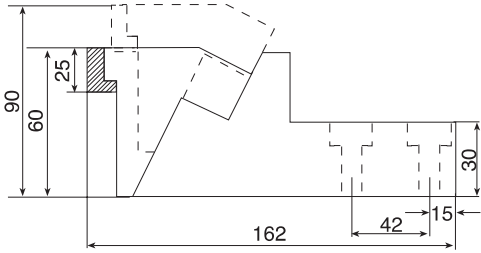

| Referans Nr. |  | Sıkma Kuvveti Clamping Force |  (kg) |
|----------------|---|---------------------------------|---|
| 2105-MYB404114 | 14 | 3000 | 2.80 |
| 2105-MYB404116 | 16 | 3000 | 2.80 |
| 2105-MYB404118 | 18 | 3000 | 2.80 |
| 2105-MYB404120 | 20 | 3000 | 2.80 |
| 2105-MYB404122 | 22 | 3000 | 2.80 |
| 2105-MYB404124 | 24 | 3000 | 2.80 |

Ürün Nr. 2105 Blok Yandan Bağlama
Product Nr. 2105 Block Side Press

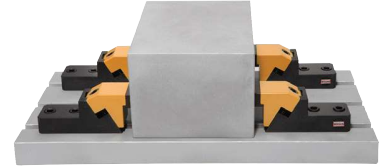

Genişlik / Width 54 mm.



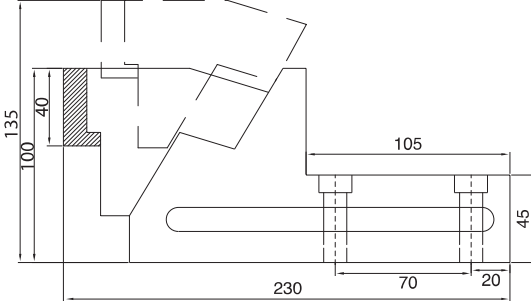

| Referans Nr. |  | Sıkma Kuvveti Clamping Force |  (kg) |
|----------------|---|---------------------------------|---|
| 2105-MYB901120 | 20 | 3000 | 6.85 |
| 2105-MYB901122 | 22 | 3000 | 6.85 |
| 2105-MYB901124 | 24 | 3000 | 6.85 |
| 2105-MYB901128 | 28 | 3000 | 6.85 |

Ürün Nr. 2105 Blok Yandan Bağlama
Product Nr. 2105 Block Side Press



Genişlik / Width 68 mm.



| Referans Nr. |  | Sıkma Kuvveti Clamping Force |  (kg) |
|----------------|---|---------------------------------|---|
| 2105-MYB303114 | 14 | 3000 | 2.80 |
| 2105-MYB303116 | 16 | 3000 | 2.80 |
| 2105-MYB303118 | 18 | 3000 | 2.80 |
| 2105-MYB303120 | 20 | 3000 | 2.80 |
| 2105-MYB303122 | 22 | 3000 | 2.80 |
| 2105-MYB303124 | 24 | 3000 | 2.80 |

Ürün Nr. 2105 Blok Yandan Bağlama
Product Nr. 2105 Block Side Press

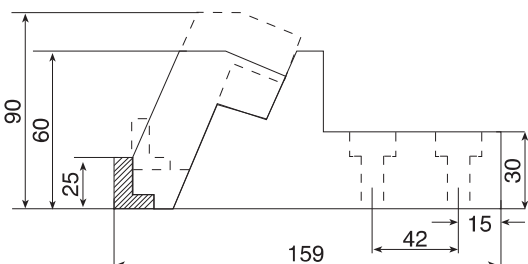

Genişlik / Width 54 mm.



| Referans Nr. | a | (kg) |
|---------------|----|------|
| 2105-MD404214 | 14 | 1.86 |
| 2105-MD404216 | 16 | 1.86 |
| 2105-MD404218 | 18 | 1.86 |
| 2105-MD404220 | 20 | 1.86 |
| 2105-MD404222 | 22 | 1.86 |
| 2105-MD404224 | 24 | 1.86 |

Ürün Nr. 2105 Blok Yandan Bağlama Dayaması
Product Nr. 2105 Block Stopper Side Press

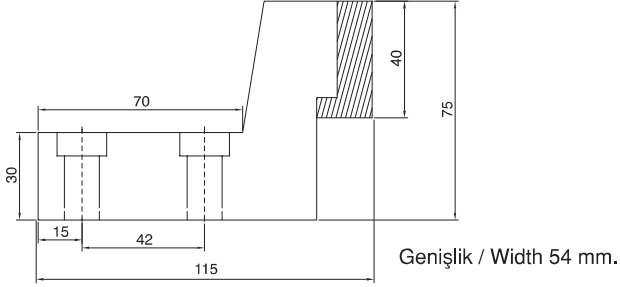

| Referans Nr. | a | (kg) |
|---------------|----|------|
| 2105-MD902120 | 20 | 4.50 |
| 2105-MD902122 | 22 | 4.50 |
| 2105-MD902124 | 24 | 4.50 |
| 2105-MD902128 | 28 | 4.50 |

Ürün Nr. 2105 Blok Yandan Bağlama Dayaması
Product Nr. 2105 Block Stopper Side Press

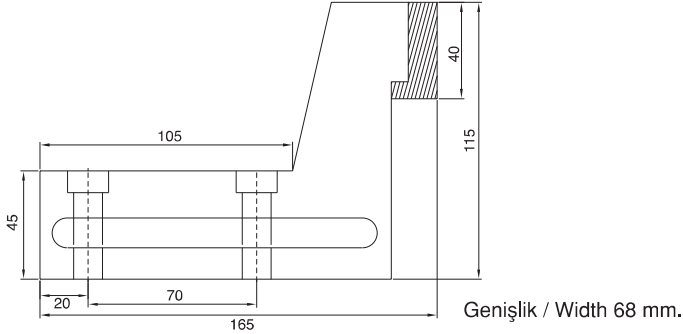

| Referans Nr. | a | (kg) |
|---------------|----|------|
| 2105-MD303214 | 14 | 1.17 |
| 2105-MD303216 | 16 | 1.17 |
| 2105-MD303218 | 18 | 1.17 |
| 2105-MD303220 | 20 | 1.17 |
| 2105-MD303222 | 22 | 1.17 |
| 2105-MD303224 | 24 | 1.17 |

Ürün Nr. 2105 Blok Yandan Bağlama Dayaması
Product Nr. 2105 Block Stopper Side Press

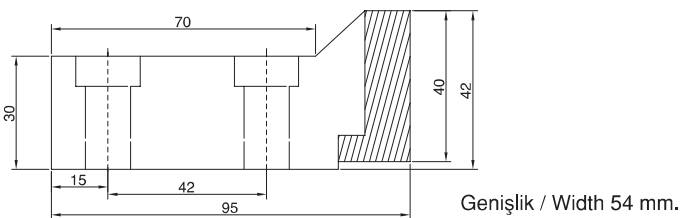

| Referans Nr. | a | c | h | b | L | L1 | L2 | sw | d | Sıkma Kuvveti Clamping Force | | |
|--------------|----|---|------|----|-----|----|----|----|-----|---------------------------------|-----------|------|
| | | | | | | | | | | f1 Kgf | f2 Kgf | |
| 2110-12 | 12 | 3 | 20 | 40 | 80 | 39 | 26 | 6 | M10 | 1600 | 60 | 415 |
| 2110-14 | 14 | | | | | | | | | 2200 | 90 | 425 |
| 2110-16 | 16 | | | | | | | | | 3200 | 120 | 785 |
| 2110-18 | 18 | 4 | 25 | 50 | 100 | 46 | 34 | 8 | M14 | 3600 | 140 | 810 |
| 2110-20 | 20 | | | | | | | | | 3600 | 140 | 850 |
| 2110-22 | 22 | | | | | | | | | 3600 | 140 | 2275 |
| 2110-24 | 24 | 5 | 28.5 | 78 | 140 | 65 | 50 | 10 | M20 | 3600 | 140 | 2360 |
| 2110-28 | 28 | | | | | | | | | 4000 | 160 | 2500 |

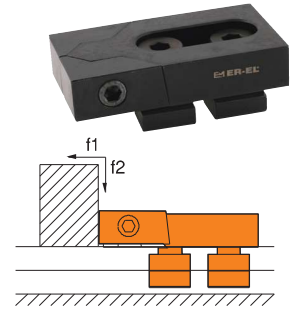

Ürün Nr. 2110 Çift Çeneli Yandan Bağlama

- İş parçasını dayama ve pleyt yönünde sıkar, pabucun yapısından dolayı kuvvetli sıkma yapar.
- Sertleştirilmiş
- Siyah kaplama

Product Nr. 2110 Side Press Clamp with Double Claw

- Product clamps the work piece in the direction of rest and plate. It achieves powerful clamping because of the clamp's structure.
- Hardened
- Black coating

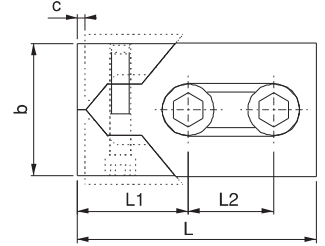
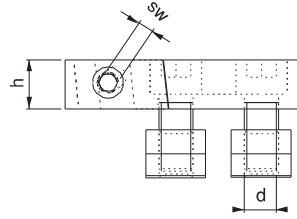

| Referans Nr. | a | a h6 | b -0.6 | c DIN 650 | d ±0.01 | h1 ±0.01 | h1 ±0.02 | h2 | h3 | ISO 4762 | |
|--------------|----|---------|--------|--------------|---------|----------|----------|----|----|----------|-----|
| | | | | | | | | | | | |
| 2120-1425 | 14 | 0-0.011 | 14 | 24 | 32 | 25 | - | 9 | 8 | M8x35 | 200 |
| 2120-1450 | 14 | 0-0.011 | 14 | 24 | 32 | - | 50 | 9 | 8 | M8x60 | 355 |
| 2120-1825 | 18 | 0-0.011 | 18 | 30 | 40 | 25 | - | 15 | 10 | M10x40 | 360 |
| 2120-1850 | 18 | 0-0.011 | 18 | 30 | 40 | - | 50 | 15 | 10 | M10x65 | 600 |
| 2120-2225 | 22 | 0-0.013 | 22 | 38 | 40 | 25 | - | 15 | 14 | M10x50 | 410 |
| 2120-2250 | 22 | 0-0.013 | 22 | 38 | 40 | - | 50 | 15 | 14 | M10x75 | 650 |

Silindir Dayama

Cylinder Pluggable



Ürün Nr. 2120 Silindir Dayama

- Sertleştirilmiş
- Siyah Kaplama

Product Nr. 2120 Cylinder Pluggable

- Hardened
- Black coating

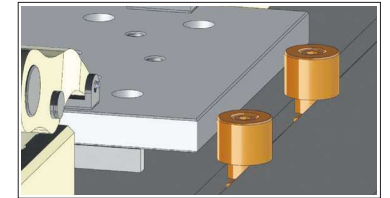
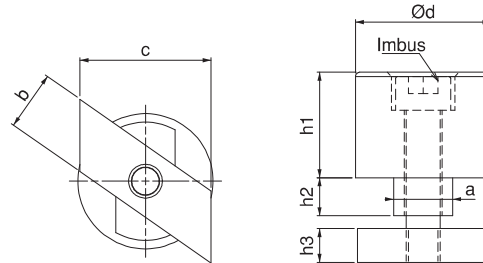

| Referans Nr. | a | n | e | c | d | b | h | k | L | sw | |
|--------------|----|------|----|----|-----|------|---|----|----|----|------|
| | | | | | | | | | | | |
| 2130-12 | 12 | 11.7 | 18 | 18 | M8 | 9 | 3 | 7 | 36 | 6 | 100 |
| 2130-14 | 14 | 13.7 | 22 | 22 | M8 | 11 | 4 | 8 | 44 | 6 | 180 |
| 2130-16 | 16 | 15.7 | 25 | 25 | M12 | 12.5 | 5 | 9 | 50 | 10 | 270 |
| 2130-18 | 18 | 17.7 | 28 | 28 | M12 | 14 | 5 | 10 | 56 | 10 | 355 |
| 2130-20 | 20 | 19.7 | 32 | 32 | M16 | 16 | 5 | 12 | 64 | 14 | 570 |
| 2130-22 | 22 | 21.7 | 35 | 35 | M16 | 17.5 | 6 | 14 | 70 | 14 | 770 |
| 2130-24 | 24 | 23.7 | 40 | 40 | M20 | 20 | 6 | 16 | 80 | 17 | 1180 |
| 2130-28 | 28 | 27.7 | 44 | 44 | M20 | 22 | 6 | 18 | 88 | 17 | 1560 |

Dayama

Clamp Rest





Ürün Nr. 2130 Dayama

- Dayama referans alma, uzunlamasına ve enlemesine kullanılır.
- Sertleştirilmiş
- Siyah kaplama

Product Nr. 2130 Clamp Rest

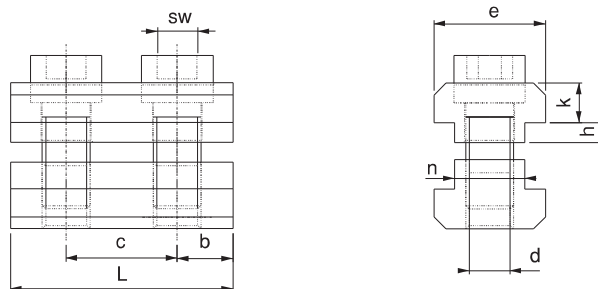
- Clamp Rest is used for reference taking, longitudinal and cross-wise.
- Hardened
- Black coating



| Referans Nr. | Stopersiz Kullanım In Use Without Slip Stopper | | Stoperli Kullanım In Use With Slip Stopper | |  (kg) |
|--------------|---|--|---|--|---|
| | Sıkma Kuvveti Clamping Force Kgf | Tork Değeri Allowable Screw Torque (N-m) | Sıkma Kuvveti Clamping Force Kgf | Tork Değeri Allowable Screw Torque (N-m) | |
| 2135-1260 | 2900 | 38 | 6900 | 90 | 2.4 |

M12 civata için 4 adet pul dahildir.
4 washers for M12 bolts are included.

Ürün Nr. 2135 Yandan Bağlama

- Gövde**
- Malzeme: Dökme Demir
 - Siyah kaplama
- Çene**
- Sertleştirilmiş
 - Siyah Kaplama
- Civata**
- Sertlik: İndüksiyon
 - Siyah Kaplama

Product Nr. 2135 Side Clamps

- Body**
- Material: Cast Iron
 - Black coating
- Jaw**
- Hardened
 - Black coating
- Bolt**
- Hardness: Induction
 - Black coating

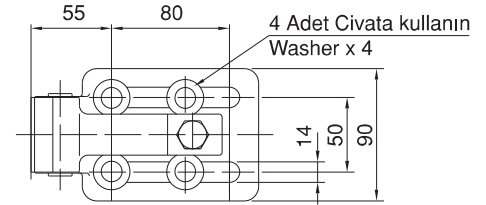
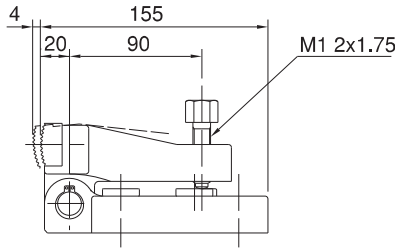
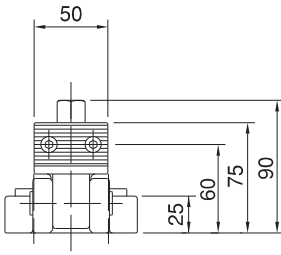

Yandan Bağlama

Side Clamps

| Referans Nr. | Sıkma Kuvveti Clamping Force Kgf | Tork Değeri Allowable Screw Torque (N-m) |  (kg) |
|--------------|--|--|---|
| 2137-16060 | 5800 | 150 | 2.9 |

M12 ve M16 vidalar için 2 adet dereceli pul dahildir.
2 spherical washers for both M12 and M16 screws are included.

Ürün Nr. 2137 Yandan Bağlama

- Gövde**
- Malzeme: Dökme Demir
 - Siyah kaplama
- Çene**
- Sertleştirilmiş
 - Siyah Kaplama
- Civata**
- Sertlik: İndüksiyon
 - Siyah Kaplama

Product Nr. 2137 Side Clamps

- Body**
- Material: Cast Iron
 - Black coating
- Jaw**
- Hardened
 - Black coating
- Bolt**
- Hardness: Induction
 - Black coating

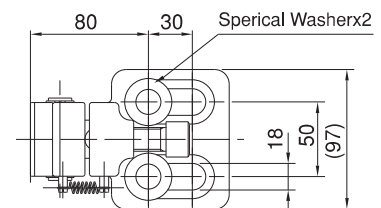
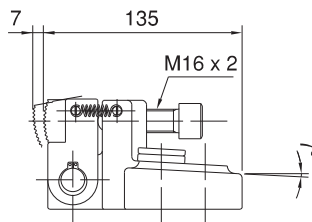
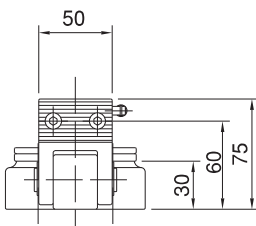

| Referans Nr. | W1 | W2 | H1 | H2 | M | P1 | H4 | L4 | W | L3 | H5 | d | L5 | P |
|--------------|----|----|----|----|--------|----|----|----|-----|----|----|-----|----|----|
| 2139-32150 | 45 | 15 | 27 | 18 | M4x0.7 | 30 | 18 | 13 | 75 | 20 | 8 | 6.6 | 3 | 60 |
| 2139-40200 | 60 | 20 | 33 | 22 | M5x0.8 | 40 | 22 | 17 | 100 | 26 | 10 | 8.6 | 4 | 80 |

| Referans Nr. | H | L | L2 | R | L1 | H3 | M1 |
|--------------|----|----|----|----|------|----|--------|
| 2139-32150 | 32 | 51 | 48 | 63 | 51.5 | 18 | M4x0.7 |
| 2139-40200 | 40 | 67 | 63 | 80 | 67 | 22 | M5x0.8 |

| Referans Nr. | A | Sıkma Torku Clamping Stroke | Çalışma Yüğü Operating Load (N) | Sıkma Kuvveti Clamping Force Kgf |  |
|--------------|----|--------------------------------|------------------------------------|-------------------------------------|---|
| 2139-32150 | 19 | 1.6 | 150 | 200 | 620 |
| 2139-40200 | 24 | 2.2 | 200 | 300 | 1360 |



Ürün Nr. 2139 Tek Dokunuş Yandan Bağlama

- Siyah kaplama

Product Nr. 2139 Cam Edge Clamps

- Black coating

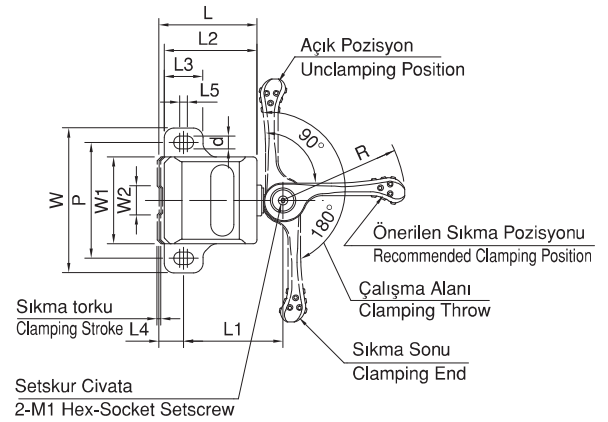
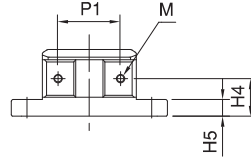
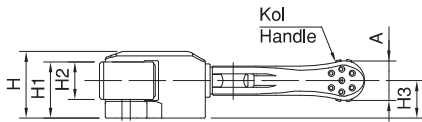

Özellikler

- Kol ile tek dokunuşta sıkma.
- Finiş işlerde mükemmel bağlama.
- Parçanın kalkmaması için çeneyi aşağı ve ileri iter.

Features

- The cam handle allows fast clamping in single operation.
- Precision-ground jaw is perfect for clamping the workpiece on its finished surface.
- In clamping, the jaw provides downward force to prevent part lift.

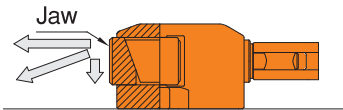

Kullanım Şekli How To Use

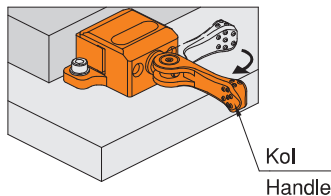

Kol Konumunu Değiştirme

90 derece 4 opsiyonlu kullanım

Changing Handle Position

The handle shaft has 4 countersinks which are provided every 90° for 4 options of handle position

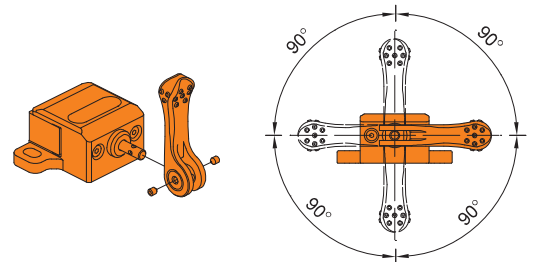

| Referans Nr. | Sıkma Torku Clamping Stroke | W1 | W2 | H3 | H4 | L2 | W | L | H2 | d | P | H5 | L1 |
|--------------|--------------------------------|----|----|----|----|----|----|------|----|-----|----|----|------|
| 2141-00010 | 1 | 38 | 8 | 6 | 3 | 15 | 45 | 33.5 | 10 | 5.2 | 36 | 5 | 30.5 |
| 2141-00015 | 2 | 60 | 12 | 9 | 5 | 22 | 70 | 50 | 15 | 8.2 | 55 | 7 | 46 |

| Referans Nr. | H | D | H1 | R | A | W3 | M1 | İzin Verilen Tork Allowable Screw Torque (N m) | Sıkma Kuvveti Clamping Force Kgf | |
|--------------|----|----|----|-----|----|----|--------|---|--|-----|
| 2141-00010 | 30 | 13 | 20 | 63 | 12 | 6 | M4x0.7 | 10 | 400 | 85 |
| 2141-00015 | 46 | 19 | 30 | 100 | 18 | 10 | M5x0.8 | 27 | 600 | 290 |

Ürün Nr. 2141 Yandan Bağlama

- Gövde**
- Siyah kaplama
- Çene**
- Sertleştirilmiş
 - Siyah Kaplama

Product Nr. 2141 Side Clamps

- Body**
- Black coating
- Jaw**
- Hardened
 - Black coating

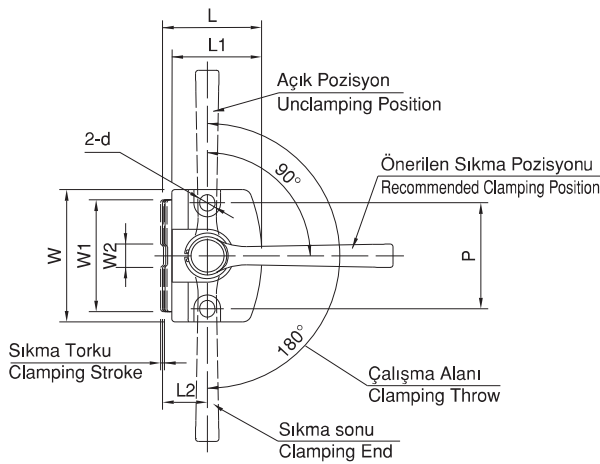

Kullanım Şekli / How To Use

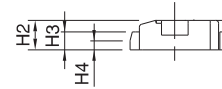
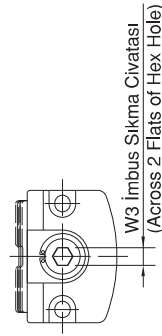
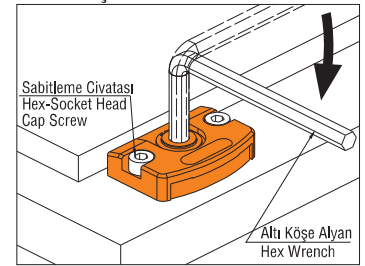

Yandan Bağlama

Side Clamp

| Referans Nr. | S | W | W1 | H1 | L1 | P | D (h7) | H2 | M | L | H | T | Sıkma Kuvveti Clamping Force Kgf | Tork Değeri Allowable Screw Torque (N-m) | |
|--------------|---|----|----|----|------|----|-----------|----|-----|----|----|-----|--|---|-----|
| 2143-08015 | 3 | 25 | 10 | 25 | 21.5 | 10 | 6 | 7 | M8 | 32 | 15 | 1.6 | 700 | 25 | 115 |
| 2143-10019 | 4 | 30 | 11 | 32 | 26 | 12 | 6 | 7 | M10 | 40 | 19 | 2 | 850 | 50 | 225 |
| 2143-12023 | 5 | 35 | 12 | 38 | 33 | 16 | 8 | 10 | M12 | 50 | 23 | 2.3 | 2000 | 90 | 390 |
| 2143-16025 | 6 | 40 | 14 | 45 | 40 | 20 | 10 | 10 | M16 | 60 | 25 | 3.2 | 3000 | 150 | 640 |

Ürün Nr. 2143 Yandan Bağlama

- Sertleştirilmiş
- Siyah Kaplama

Product Nr. 2143 Side Clamps

- Hardened
- Black coating



Kurulum ve Kullanım Şekli / How To Use and Install

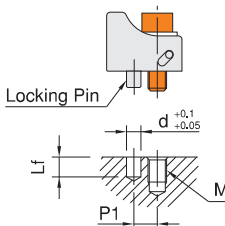

| Nr. | M1 | d | Lf | P1 |
|-------------|-----|----|----|----|
| CP107-08015 | M 8 | 6 | 8 | 10 |
| CP107-10019 | M10 | 6 | 8 | 12 |
| CP107-12023 | M12 | 8 | 11 | 16 |
| CP107-16025 | M16 | 10 | 11 | 20 |

Üst tarafta görüldüğü gibi sabitlemek için bir pim, bir civata deliği gerekli.

Drill a cap-screw hole and a locking-pin hole as specified on the up.

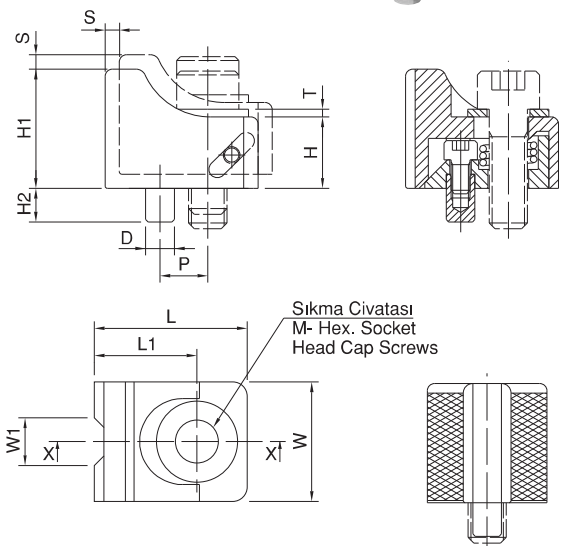

| Referans Nr. | s | w | w1 | h1 | L1 | P | d (h7) | h2 | M | L | h | t | Sıkma Kuvveti Clamping Force (N) | İzin Verilen Vida Torku Allowable Screw Torque (N·m) | (g) |
|--------------|---|----|----|----|------|----|--------|----|-----|----|----|-----|----------------------------------|--|-----|
| 2144-08015 | 3 | 25 | 10 | 6 | 24.5 | 10 | 6 | 7 | M8 | 35 | 15 | 1.6 | 7.000 | 25 | 100 |
| 2144-10019 | 4 | 30 | 11 | 8 | 29 | 12 | 6 | 7 | M10 | 43 | 19 | 2 | 8.500 | 50 | 185 |
| 2144-12023 | 5 | 35 | 12 | 9 | 37 | 16 | 8 | 10 | M12 | 54 | 23 | 2.3 | 20.000 | 90 | 320 |
| 2144-16025 | 6 | 40 | 14 | 10 | 45 | 20 | 10 | 10 | M16 | 65 | 25 | 3.2 | 30.000 | 150 | 520 |

Ürün Nr. 2144 Yandan Bađlama

- Sertleştirilmiş
- Siyah kaplama

Product Nr. 2144 Side Clamp

- Hardened
- Black coating

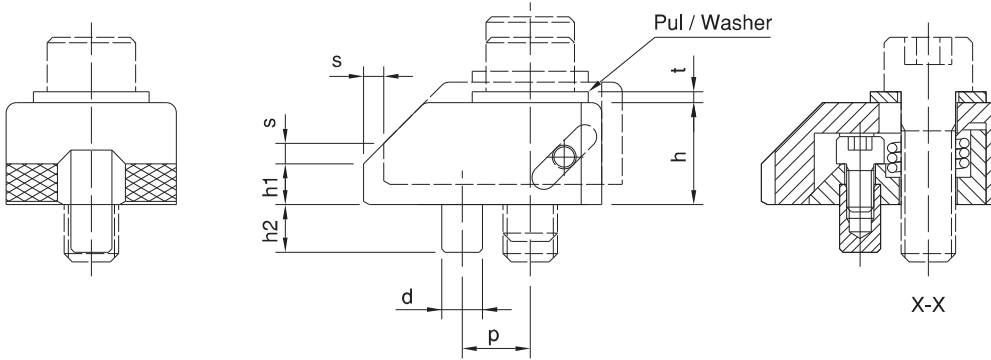
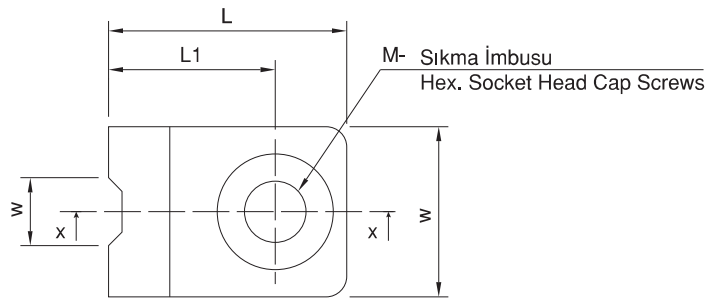
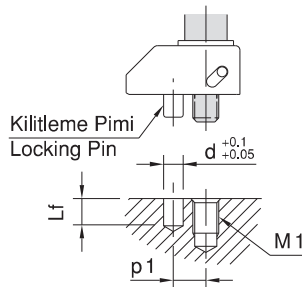
Uygulama Örneđi / Application Example

| Referans Nr. | M1 | d | Lf | p1 |
|--------------|-----|----|----|----|
| 2144-08015 | M 8 | 6 | 8 | 10 |
| 2144-10019 | M10 | 6 | 8 | 12 |
| 2144-12023 | M12 | 8 | 11 | 16 |
| 2144-16025 | M16 | 10 | 11 | 20 |

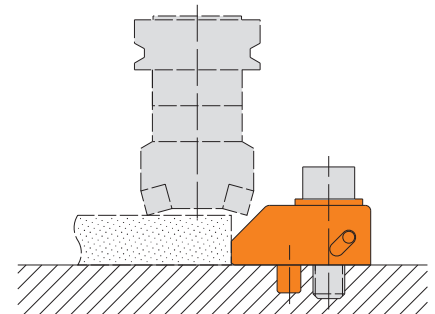

| Referans Nr. |  | s1 | m | sw | L | h | k | n | b | Sıkma Kuvveti Clamping Force kgf | |
|--------------|---|-----|----|----|----|-----|----|------|----|--|-----|
| | | | | | | | | | | (g) | (g) |
| 2150-08 | 8 | 1,4 | 5 | 4 | 23 | 9,5 | 6 | 7,7 | 13 | 310 | 25 |
| 2150-10 | 10 | 1,4 | 5 | 4 | 23 | 14 | 6 | 9,7 | 15 | 310 | 35 |
| 2150-12 | 12 | 1,2 | 7 | 5 | 28 | 15 | 7 | 11,7 | 18 | 340 | 60 |
| 2150-14 | 14 | 1,7 | 7 | 7 | 30 | 22 | 8 | 13,7 | 22 | 800 | 95 |
| 2150-16 | 16 | 1,7 | 10 | 8 | 30 | 22 | 9 | 15,7 | 25 | 1500 | 130 |
| 2150-18 | 18 | 2 | 10 | 8 | 35 | 28 | 10 | 17,7 | 28 | 1500 | 190 |
| 2150-20 | 20 | 2,5 | 13 | 10 | 40 | 32 | 12 | 19,7 | 32 | 2000 | 290 |
| 2150-22 | 22 | 2,5 | 13 | 12 | 45 | 38 | 14 | 21,7 | 35 | 2000 | 390 |

Ürün Nr. 2150 Kanal İçi Yandan Bağlama

- Ürünün T-Gövdesi tamamıyla tezgah kanalına girer. Sadece ürünün eksantrik başlığı tabla yüzeyinde kaldığı için ince parçalarda sıkma kolaylığı sağlar.
- DIN 650 T-Kanala uyumludur
- Sertleştirilmiş
- Siyah kaplama

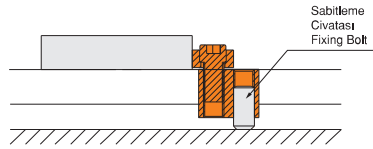
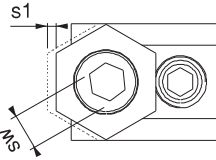
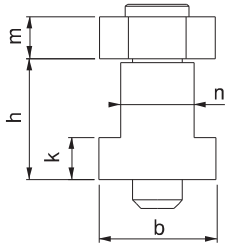
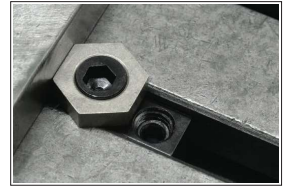

Product Nr. 2150 In-slot Side Clamp

- T-Slot of the product enters in the slot of the bench completely. Since only the eccentric headpiece remains on the surface of the table, this provides easy clampings of the thin pieces.
- It is in compliance with DIN 650 T-Slot
- Hardened
- Black coating



Yandan Bağlama Pençe Pabuç

Jaw Clamp

| Referans Nr. |  | c | n | | x | L | b | m1 | sw | Sıkma Kuvveti Clamping Force | |  |
|--------------|---|-----|-----|-----|-----|----|------|------|----|---------------------------------|-----------|---|
| | | | min | max | | | | | | f1 kgf | f2 kgf | |
| 2170-12 | 12 | 2 | 2 | 6 | 4 | 46 | 21 | 10 | 5 | 500 | 60 | 120 |
| 2170-14 | 14 | 2,5 | 2,5 | 7,5 | 5 | 51 | 26 | 10 | 6 | 550 | 70 | 200 |
| 2170-16 | 16 | 3 | 2,5 | 8,5 | 6 | 61 | 27,5 | 12 | 6 | 800 | 90 | 290 |
| 2170-18 | 18 | 3 | 2 | 8 | 6 | 67 | 35 | 13 | 8 | 900 | 100 | 420 |
| 2170-20 | 20 | 4 | 2,5 | 11 | 8,5 | 78 | 38 | 13 | 10 | 1200 | 140 | 640 |
| 2170-22 | 22 | 4,5 | 2,5 | 12 | 9,5 | 87 | 39 | 16,5 | 10 | 1600 | 190 | 830 |



Ürün Nr. 2170 Yandan Bağlama Pençe Pabuç

- İş parçasını dayama ve pleyt yönüne sıkar
- T-Kanal içinde çalışması yükseklik avantajı sağlar
- DIN 650 T-Kanala uyumludur
- Sertleştirilmiş
- Siyah kaplama

Product Nr. 2170 Jaw Clamp

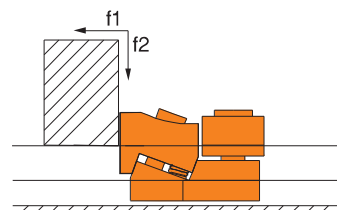
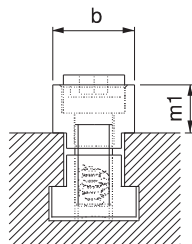
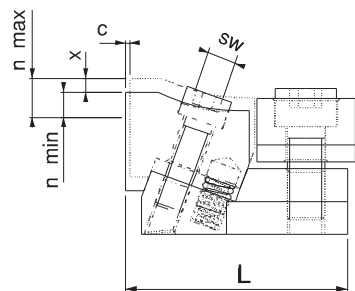
- This product clamps the workpiece in the direction of resting and plate
- It's working in T-Slot provides height advantage
- It is in compliance with DIN 650 T-Slot
- Hardened
- Black coating



| Referans Nr. | c | |  | m | k | b | L | e ^e DIN 912 | Sıkma Kuvveti Clamping Force kgf |  (g) |
|--------------|-----|-----|---|----|---|----|----|---------------------------|--|--|
| | min | max | | | | | | | | |
| 2190-5055 | 50 | 55 | 14-16-18-20-22 | 35 | 4 | 30 | 42 | M12 | 1750 | 390 |

Ürün Nr. 2190 Çift Açılır Yandan Bağlama

- Bir noktadan iki yöne ve pleyt yönüne doğru sıkma işlemi yapar.
- M12 diş pleytlerde ve (a) 14-16-18-20-22 T-Kanal ölçülerinde kullanılır.
- Sertleştirilmiş
- Siyah kaplama

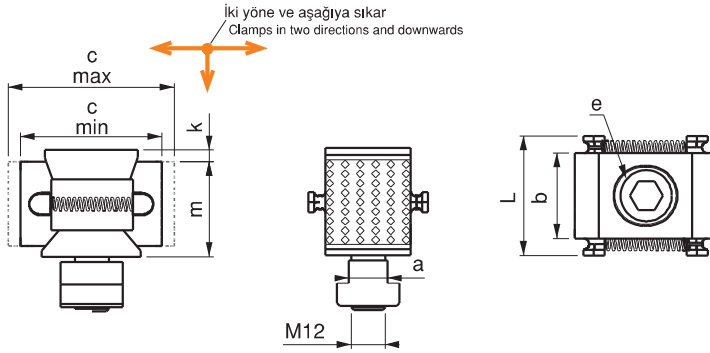
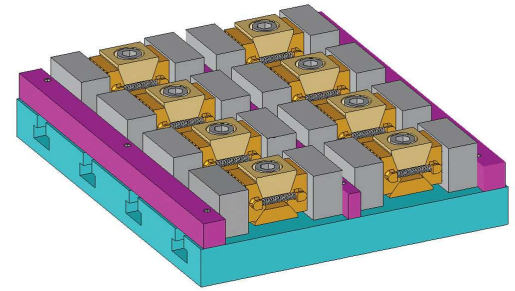

Product Nr. 2190 Side Press with Double Opening

- This product makes press process from one point to two directions and towards the direction of the plate.
- It is used in M12 thread plates and (a) 14-16-18-20-22 T-Slot measurings
- Hardened
- Black coating



Çift Açılır Yandan Bağlama

Side Press with Double Opening

| Referans Nr. | c | |  | m | k | b | L | e ^e DIN 912 | Sıkma Kuvveti Clamping Force kgf |  (g) |
|--------------|-----|-----|---|----|---|----|----|---------------------------|--|--|
| | min | max | | | | | | | | |
| 2210-4954 | 49 | 54 | 14-16-18-20-22 | 23 | 4 | 30 | 42 | M12 | 1500 | 280 |

Ürün Nr. 2210 Çift Açılır Yandan Bağlama

- Bir noktadan iki yöne sıkma işlemi yapar.
- M12 diş pleytlerde ve (a) 14-16-18-20-22 T-Kanal ölçülerinde kullanılır.
- Sertleştirilmiş
- Siyah kaplama

Product Nr. 2210 Side Press with Double Opening

- This product makes press process from one point to two directions.
- It is used in M12 thread plates and (a) 14-16-18-20-22 T-Slot measurings
- Hardened
- Black coating

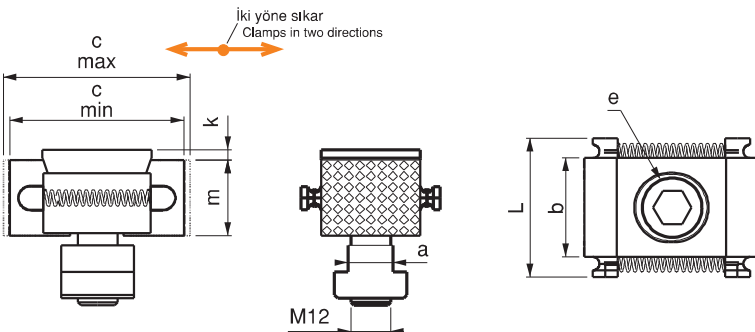
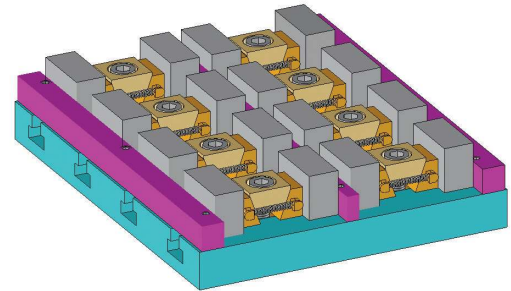

| Referans Nr. | h x b x L | tolerans tolerance h | tolerans tolerance b |  (kg) | Adet Piece |
|--------------|-----------|----------------------|----------------------|--|------------|
| 2230-028 | 14x10x150 | ±0.01 | ±0.01 | 10.8 | 2 |
| | 16x10x150 | | | | 2 |
| | 18x10x150 | | | | 2 |
| | 20x10x150 | | | | 2 |
| | 22x10x150 | | | | 2 |
| | 24x10x150 | | | | 2 |
| | 26x10x150 | | | | 2 |
| | 28x10x150 | | | | 2 |
| | 30x10x150 | | | | 2 |
| | 32x10x150 | | | | 2 |
| | 35x10x150 | | | | 2 |
| | 40x10x150 | | | | 2 |
| | 45x10x150 | | | | 2 |
| 50x10x150 | 2 | | | | |

Ürün Nr. 2230 Paralel Set-28

- Ürün iş parçalarının paralel bağlanmasında ve hassas işlenmesinde altlık olarak kullanılır.
- 28 parça
- Sertleştirilmiş
- Ahşap kutuda set

Product Nr. 2230 Parallel Set-28

- This product is used for parallel coupling of the workpieces and as the base for sensitive machinings of the work pieces.
- 28 pieces.
- Hardened
- Set is in the wooden box

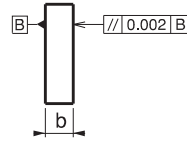
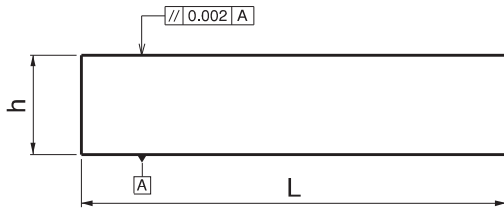
Paralel Set

Parallel Set

| Referans Nr. | h x b x L | tolerans tolerance h | tolerans tolerance b |  (kg) | Adet Piece |
|--------------|-----------|----------------------|----------------------|--|------------|
| 2250-016 | 20x6x100 | ±0.01 | ±0.01 | 10.6 | 2 |
| | 23x8x100 | | | | 2 |
| | 28x10x100 | | | | 2 |
| | 36x12x150 | | | | 2 |
| | 42x14x150 | | | | 2 |
| | 48x16x150 | | | | 2 |
| | 58x18x150 | | | | 2 |
| | 65x22x150 | | | | 2 |



Ürün Nr. 2250 Paralel Set-16

- Ürün iş parçalarının paralel bağlanmasında ve hassas işlenmesinde altlık olarak kullanılır.
- 16 parça
- Sertleştirilmiş
- Ahşap kutuda set

Product Nr. 2250 Parallel Set-16

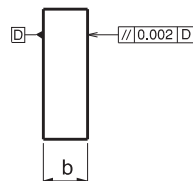
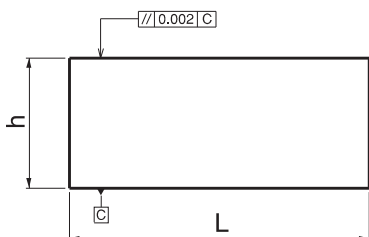
- This product is used for parallel coupling of the workpieces and as the base for sensitive machinings of the work pieces.
- 16 pieces.
- Hardened
- Set is in the wooden box

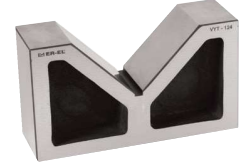

| Referans Nr. | a | b | c | \varnothing_v | |  (g) |
|--------------|-----|-----|----|-----------------|-----|--|
| | | | | min | max | |
| 2270-140 | 140 | 82 | 40 | 20 | 110 | 1980 |
| 2270-204 | 204 | 115 | 66 | 15 | 150 | 6150 |

Ürün Nr. 2270 V-Yatak

- Malzeme : Döküm
- Silindir parçaların paralel bağlanmasında ve hassas işlenmesinde altlık olarak kullanılır.
- İkilî takım

Product Nr. 2270 V-Clamping Block

- Material: Casting
- This product is used in parallel couplings of cylindrical pieces and it is also used as the base for sensitive machinings of the workpieces.
- Set of two pieces

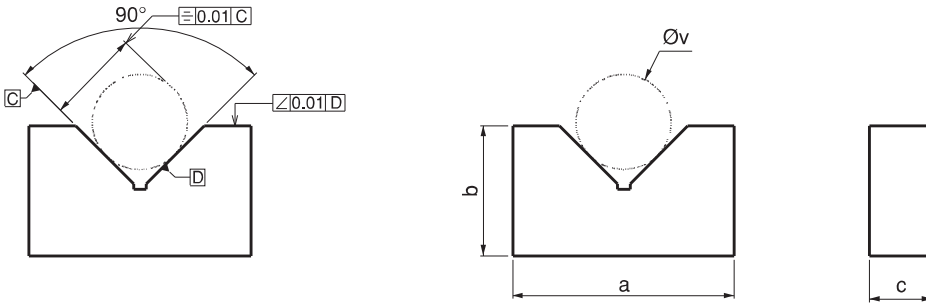
XV-Yatak

XV-Clamping Block

| Referans Nr. | a | b | c | \varnothing_{v1} | | \varnothing_{v2} | | \varnothing_{v3} | | \varnothing_{v4} | |  (g) |
|--------------|-----|-----|----|--------------------|-----|--------------------|-----|--------------------|-----|--------------------|-----|---|
| | | | | min | max | min | max | min | max | min | max | |
| 2290-120 | 120 | 100 | 60 | 12 | 40 | 12 | 60 | 12 | 75 | 12 | 90 | 2840 |
| 2290-150 | 152 | 132 | 74 | 15 | 80 | 15 | 95 | 15 | 110 | 15 | 120 | 4975 |



Ürün Nr. 2290 XV-Yatak

- Malzeme : Döküm
- Silindir parçaların paralel bağlanmasında hassas işlenmesinde altlık olarak kullanılır, X formunda olmasından dolayı 4 ayrı yüzeyi kullanma avantajı sağlar.
- İkilî takım

Product Nr. 2290 XV-Clamping Block

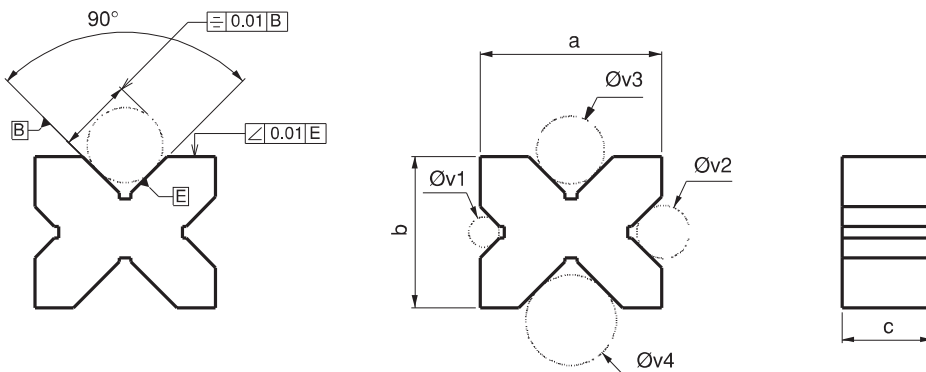
- Material: Casting
- This product is used in parallel couplings of cylindrical pieces and it is also used as the base for sensitive machinings of the workpieces. It provides using advantage in 4 different surfaces because of being in X form.
- Set of two pieces



| Referans Nr. | L | h | a | a1 | b | b1 | sw |  (g) |
|--------------|-----|----|----|------|-----|-------|----|--|
| 2295-090 | 90 | 39 | 55 | 73 | 7 | 21-35 | 8 | 1480 |
| 2295-115 | 115 | 49 | 65 | 82.5 | 8.5 | 31-42 | 10 | 2690 |
| 2295-130 | 130 | 56 | 75 | 98 | 10 | 37-48 | 12 | 4160 |

Ürün Nr. 2295 CNC 5 Eksen Parça Bağlama Aparatı

- İş parçasına kırılmaç yuva açılarak aparata bağlanır.
- Sertleştirilmiş
- Siyah kaplama

Product Nr. 2295 CNC 5 Axis Clamping Parts Apparatus

- Apparatus is connected at workpiece, swallow nest opening.
- Hardened
- Black coating

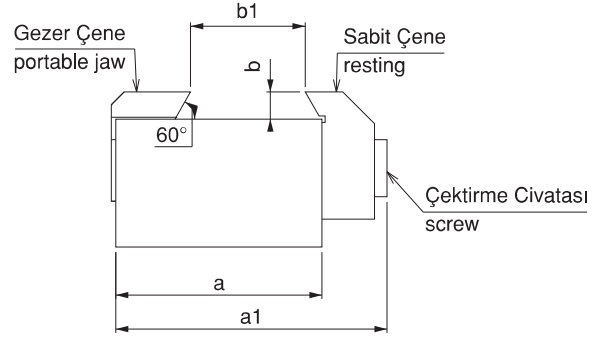
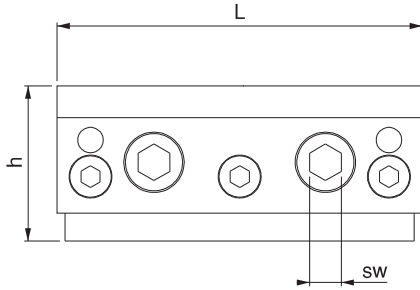

CNC 5 Eksen Parça Bağlama Takozu

CNC 5 Axis Clamping Parts Wedge

| Referans Nr. | a | h | L | d |  (g) |
|--------------|----|----|-------|-----|--|
| 2297-090 | 55 | 58 | 87 | M10 | 2110 |
| 2297-115 | 65 | 68 | 110 | M12 | 3750 |
| 2297-130 | 75 | 80 | 126.5 | M12 | 5830 |

Ürün Nr. 2297 CNC 5 Eksen Parça Bağlama Takozu

- Sertleştirilmiş
- Siyah kaplama

Product Nr. 2297 CNC 5 Axis Clamping Parts Wedge

- Hardened
- Black coating

