

MENGENELER

VICES

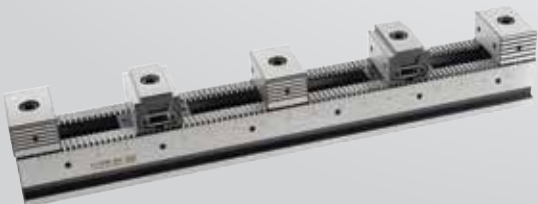

Referans Nr.	A min-max	Strok	B	C	D	E	F	ØG	H	K	K1	N	N1	S	S1	M	Q1	Q2	(kg)
2300-130	162-142	10x2	90	83	60	130	10	86	143	9	22	76	64	106	60	M8	11	6	8.50
2300-170	210-170	20x2	100	96	78	170	12	98	174	11	30	136	74	106	80	M10	11	8	14
2300-190	242-202	20x2	125	101	80	190	16	121	181	11	36	144	96	106	100	M12	13	8	21

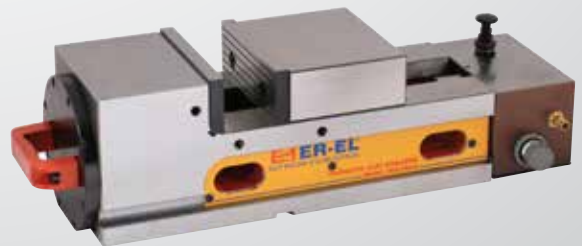
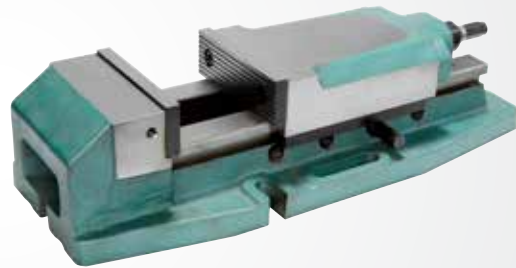
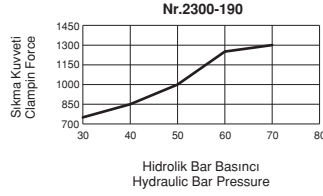
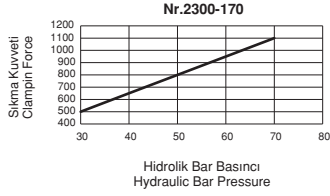
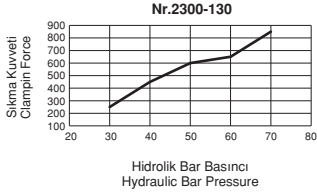

Ürün Nr. 2300 Hidrolik Çift Açılır Mengene

- Ürün işlem yapılacak malzemeyi sabitleyen aynı zamanda da merkezleme yapmaktadır. Bu sistemin avantajı özellikle dış çap ölçüleri değişken malzemelerde merkez değişmeden işlem yapılabilir. Diğer özelliği ise yumuşak çenelere işlenecek parçanın formu uygulanabilir. (1-2-3 şekillerde görüldüğü gibi.)
- Hareketli yüzeylerin tamamı hassas taşlanmış ve sertleştirilmiştir.
- Sistem hidrolik çalışır
- Yağ girişi - Yağ dönüş
- Siyah Kaplama

Product Nr. 2300 Hydraulic Centering Vice

- This product fixes the material to be processes and at the same time it makes centering. The advantage of this system specially shows itself when making machinings of the materials having different outer diameter measurements as it implements this process without changing the center. It's other characteristic is to apply the form of the piece to be machined with soft jaws (as seen in Figures: 1-2 and 3).
- Entire moving surface is sensitively grinded and hardened.
- Hydraulic system works
- Oil inlet - Oil outlet
- Black coating

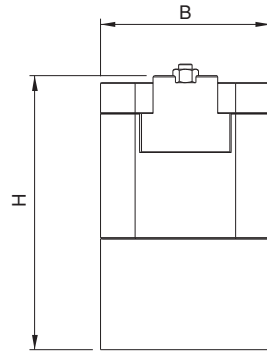
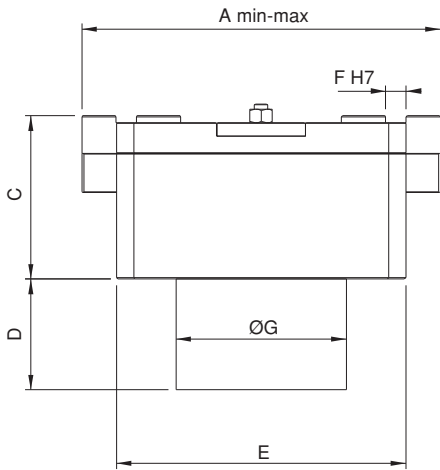

Şekil 1
Figures 1

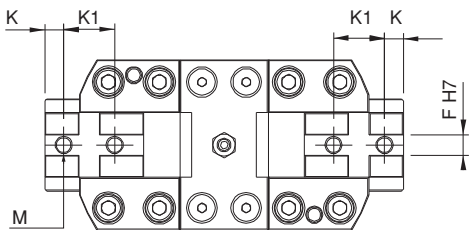
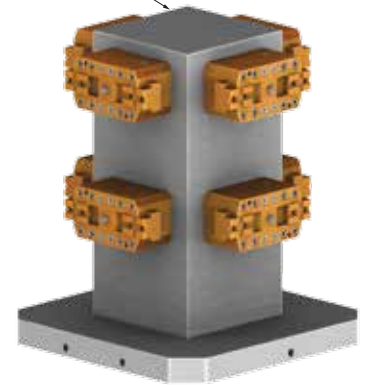

Şekil 2
Figures 2

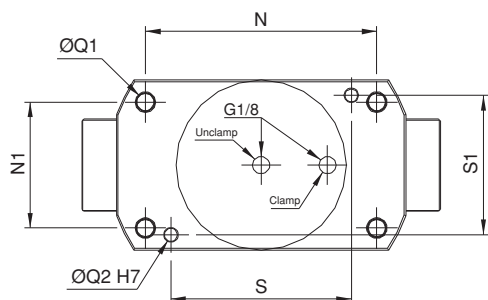
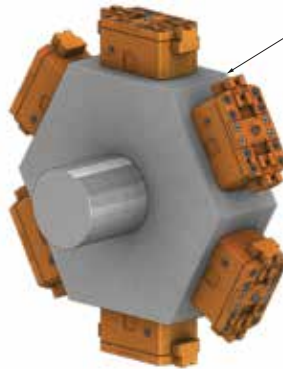

Şekil 3
Figures 3

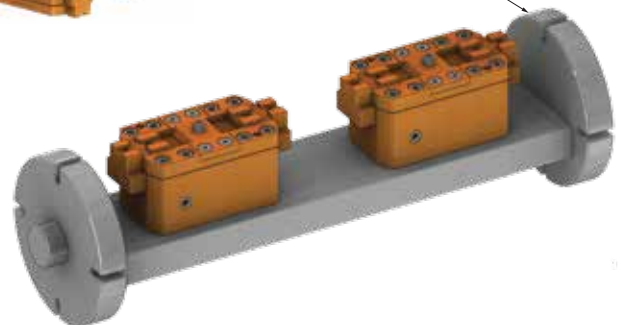

Referans Nr.	A min-max	Strok	Hydraulic Bar	Sıkma Kuvveti Clamping Force kgf	 (kg)
2305-0251	0 - 251	13 x 2	30	750	15.2
			40	1000	
			50	1250	
			60	1500	





Ürün Nr. 2305 Hidrolik Çift Açılır Mengene

- Ürün işlem yapılacak malzemei sabitlerken aynı zamanda da merkezleme yapmaktadır. Bu sistemin avantajı özellikle dış çap ölçüleri değişken malzemelerde merkez değişmeden işlem yapılabilir. Diğer özelliği ise yumuşak çenelere işlenecek parçanın formu uygulanabilir (1-2-3-4 şekillerde görüldüğü gibi.)
- Hareketli yüzeylerin tamamı hassas taşlanmış ve sertleştirilmiştir.
- Sistem hidrolik çalışır
- Yağ gidiş - Yağ dönüş
- Siyah Kaplama

Product Nr. 2305 Hydraulic Centering Vice

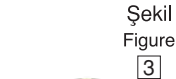
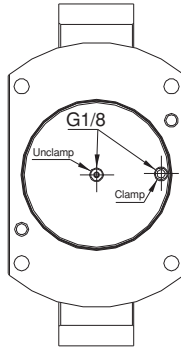
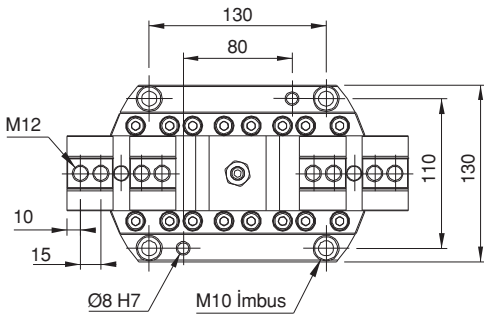
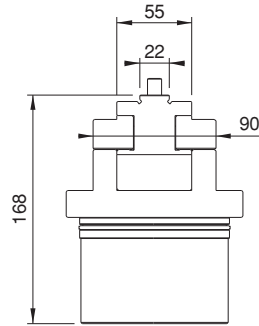
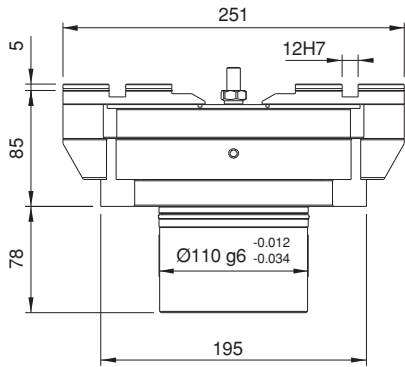
- This product fixes the material to be processes and at the same time it makes centering. The advantage of this system specially shows itself when making machinings of the materials having different outer diameter measurements as it implements this process without changing the center. It's other characteristic is to apply the form of the piece to be machined with soft claws (as seen in Figures: 1-2-3-4-5 and 6).
- Entire moving surface is sensitively grinded and hardened.
- Hydraulic system works
- Oil inlet - Oil outlet
- Black coating



Referans Nr.	A min-max	Strok	Pneumatic Bar	Sıkma Kuvveti Clamping Force kgf	 (kg)
2307-0188	0-188	8.5x2	6	750	18.5

Pnömatik Çift Açılır Mengene

Ürün Nr. 2307 Pnömatik Çift Açılır Mengene

- Sistem pnömatik çalışır.

Product Nr. 2307 Pneumatic Centering Vice

- Pneumatic system works

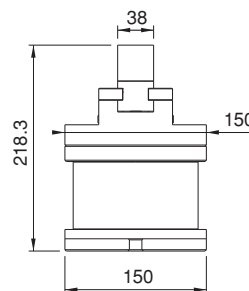
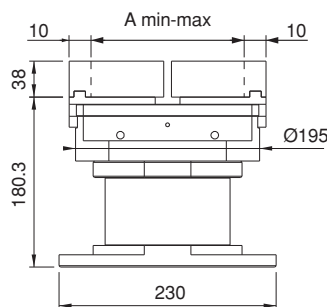
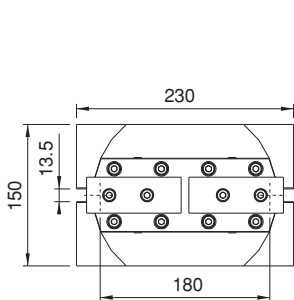

MEKANİK ÇELİK MENGENE UYGULAMASI

MECHANICAL STEEL VICE APPLICATION



Referans Nr.	a	L	c/2	açılır opens 2 x mm	iş başlama kapasitesi Work Piece Coupling Capacity (mm)	b	b1	b2 ±0,02	b3	p1	p2	s1	s2	Sıkma Kuvveti Clamping Force kgf	Tork Değeri Allowable Screw Torque (N-m)	sw	(kg)
2310-060	60	120	90	20	120	23.5	70.5	67.5	91	174	124	150	100	800	45	9	7
2310-078	78	180	130	30	180	33	97	93	126	224	124	200	100	1500	110	12	14
2310-100	100	220	154	38	220	35	99	95	130	274	174	250	150	1500	110	12	22
2310-125	125	260	174	47	260	38	108	103	141	324	174	300	150	2000	190	14	35
2310-157	157	350	208	75	350	46	123	118	164	424	224	400	200	2200	210	17	65



Ürün Nr. 2310 Çift Açılır Çelik Mengene

- Ürün işlem yapılacak malzemeyi sabitlerken aynı zamanda da merkezleme yapmaktadır.
- Bu sistemin avantajı özellikle dış çap ölçüleri değişken malzemelerde merkez değişmeden işlem yapılabilir.
- Diğer özelliği ise yumuşak çenelere işlenecek parçanın formu uygulanabilir (1-2-3-4-5-6 şekillerde görüldüğü gibi.)
- Kullanım alanı: CNC ve mekanik frezeler, taşlama, matkap gibi çeşitli sanayi makinalarında kullanılır.
- Hareketli yüzeylerin tamamı hassas taşlanmış ve sertleştirilmiştir.
- Çeneleri ayrı olarak satın almanız gerekir.
- Siyah Kaplama

Product Nr. 2310 Steel Vice with Double Opening

- This product fixes the material to be processes and at the same time it makes centering. The advantage of this system specially shows itself when making machinings of the materials having different outer diameter measurements as it implements this process without changing the center. It's other characteristic is to apply the form of the piece to be machined with soft claws (as seen in Figures: 1-2-3-4-5 and 6).
- Area of Using: This product is used in various industry machines such as CNC and mechanical milling machines, grinding and auger.
- Entire moving surface is sensitively grinded and hardened.
- You need to purchase jaws separate.
- Black coating

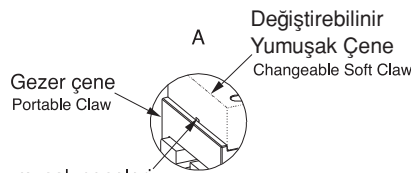
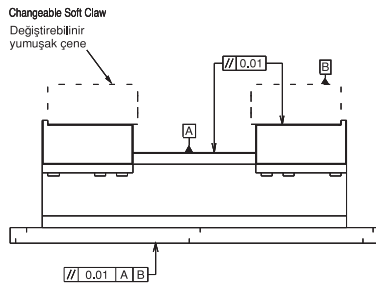
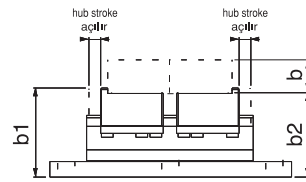
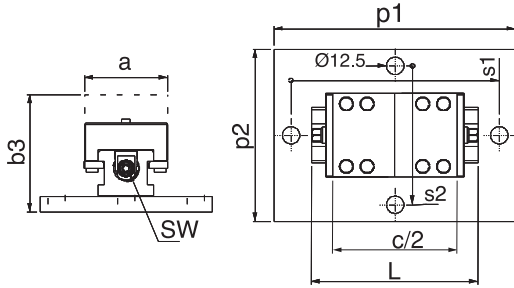
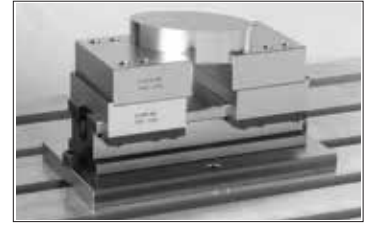

Gezer çene kaması yumuşak çeneleri söküp takma hassasiyeti ± 0.02 dir
Demounting and mounting of portable jaw wedge soft claws is ± 0.02 .

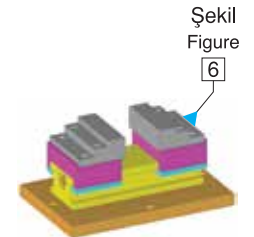
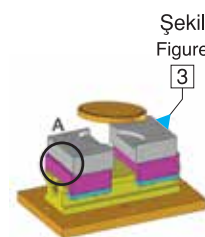
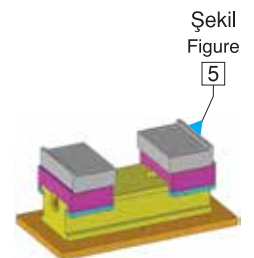
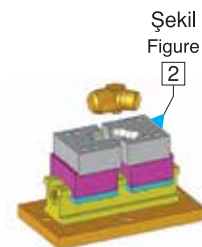
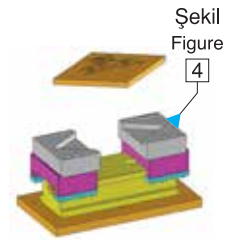
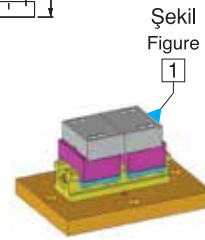

Referans Nr.	a	L	c/2	açılır opens 2 x mm	b1	b2 ±0,02	p1	p2	s1	Sıkma Kuvveti Clamping Force kgf	Tork Değeri Allowable Screw Torque (N-m)	sw	(kg)
2315-060	60	120	90	20	117.5	114.5	174	56	150	800	45	9	4.1
2315-078	78	180	130	30	159	155	224	73.5	200	1500	110	12	10
2315-100	100	220	154	38	159	155	274	95	250	1500	110	12	17.2

Ürün Nr. 2315 Çift Açılır 5-Eksen Mengene

- Ürün işlem yapılacak malzemeyi sabitlerken aynı zamanda da merkezleme yapmaktadır. Bu sistemin avantajı özellikle dış çap ölçüleri değişken malzemelerde merkez değişmeden işlem yapılabilir.
- Kullanım alanı: CNC ve CNC 5-Eksen sanayi makinalarında kullanılır.
- Hareketli yüzeylerin tamamı hassas taşlanmış ve sertleştirilmiştir.
- Çeneleri ayrı olarak satın almanız gerekir.
- Siyah Kaplama

Product Nr. 2315 Double Opening 5-Axis Vice

- This product fixes the material to be processes and at the same time it makes centering. The advantage of this system specially shows itself when making machinings of the materials having different outer diameter measurements as it implements this process without changing the center.
- Area of Using: This product is used in various industry machines such as CNC and CNC 5-Axis mechanical milling machines,
- Entire moving surface is sensitevely grinded and hardened.
- You need to purchase jaws separate.
- Black coating

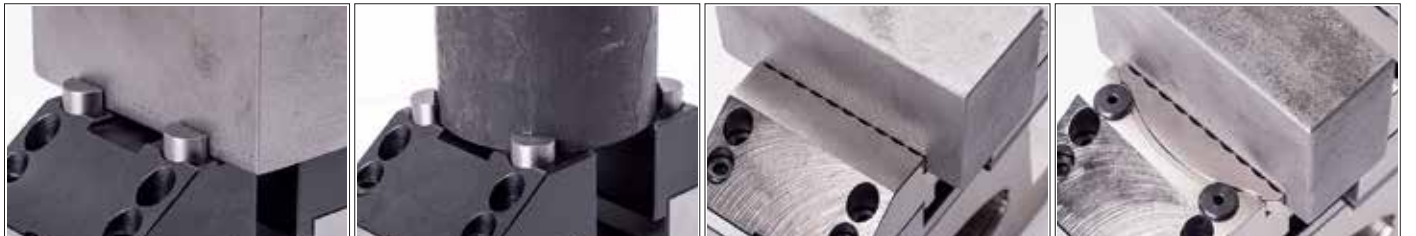
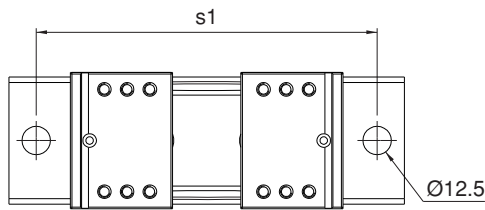
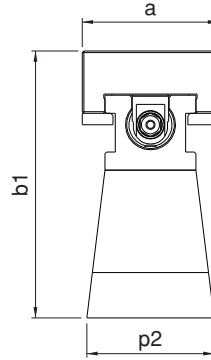
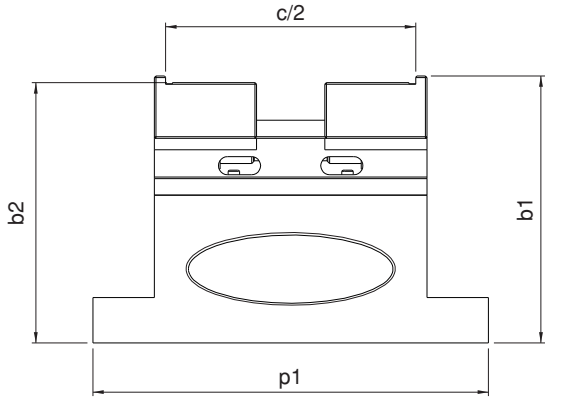

Referans Nr.	f min-max	h	h1	L1	a
2310-23150601	10-50	16.5	23.5	45	60
2310-23150781	10-70	26	33	65	78
2310-23151001	10-86	28	35	77	100
2310-23151251	10-104	31	38	87	125
2310-23151571	10-160	39	46	104	157

- Sertleştirilmiş
- Nikel Kaplama
- Hardened
- Nickel Coating

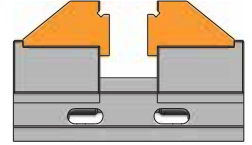
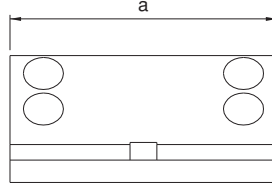
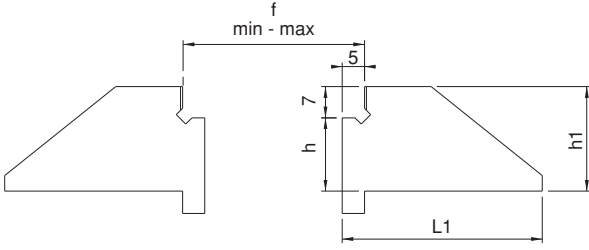

Nr.2310 ve Nr.2315 Kodlu Ürünlerle Uyumludur.

Referans Nr.	f min-max	h	h1	L1	a
2310-23150602	8-48	20.5	23.5	45	60
2310-23150782	8-68	29	33	65	78
2310-23151002	8-84	31	35	77	100
2310-23151252	8-102	34	38	87	125
2310-23151572	8-158	46	46	104	157

- Sertleştirilmiş
- Nikel Kaplama
- Hardened
- Nickel Coating

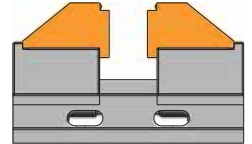
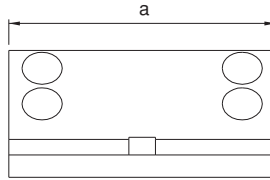
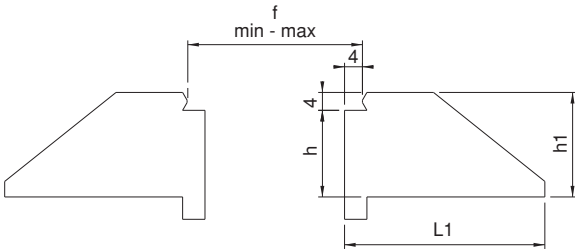

Nr.2310 ve Nr.2315 Kodlu Ürünlerle Uyumludur.

Referans Nr.	f min-max	h	h1	L1	a
2310-23150603	10-50	16.5	23.5	47	60
2310-23150783	10-70	26	33	67	78
2310-23151003	10-86	28	35	79	100

- Sertleştirilmiş
- Nikel Kaplama
- Hardened
- Nickel Coating

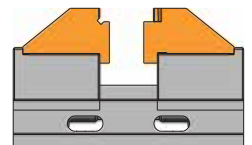
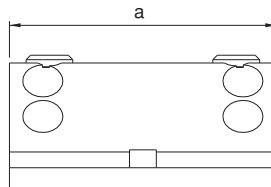
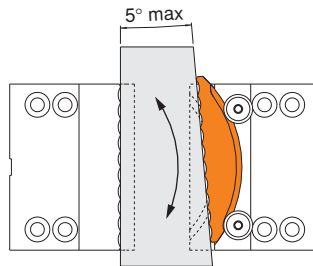
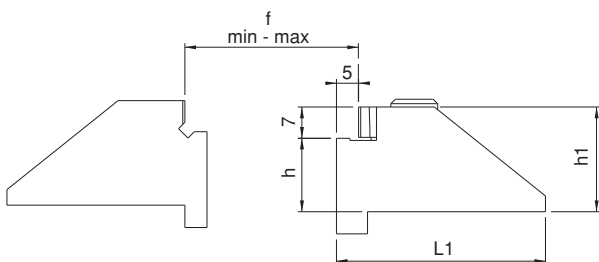

Nr.2310 ve Nr.2315 Kodlu Ürünlerle Uyumludur.

Referans Nr.	f		h	h1	L1	a
	min	max				
2310-23150604	46-72	23-63	23.5	27.5	45	60
2310-23150784	59-95	23-83	33	37	65	78
2310-23151004	77-124	23-99	35	39	77	100

- Satın almadan önce çene özelliğini belirtiniz. (Tırtıl veya Düz)
- Sertleştirilmiş
- Siyah Kaplama

- You should specify the jaw feature before make purchase. (Serrated or Straight)
- Hardened
- Black Coating

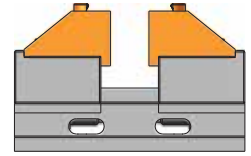
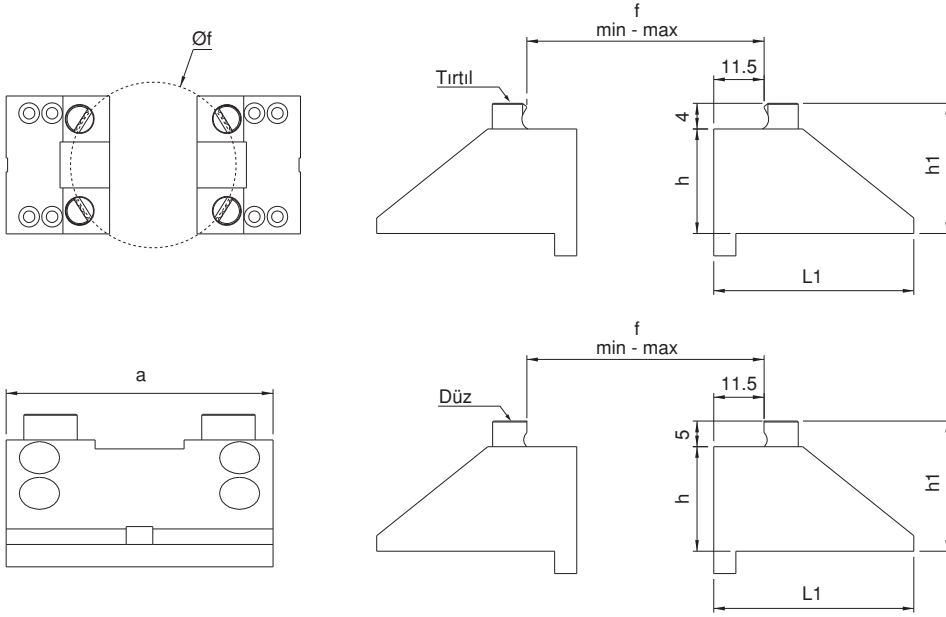

Nr.2310 ve Nr.2315 Kodlu Ürünlerle Uyumludur.

Referans Nr.	f min-max	f1 min-max	h	h1	g	L1	a
2310-23150785	10-70	20-80	10	33	16	65	78
2310-23151005	10-86	20-96	10	35	18	77	100
2310-23151255	10-104	20-114	10	38	21	87	125
2310-23151575	10-160	20-170	10	46	29	104	157

- Sertleştirilmiş
- Nikel Kaplama
- Hardened
- Nickel Coating

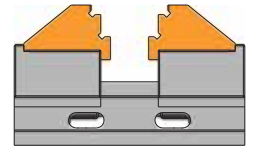
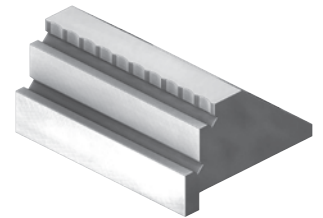
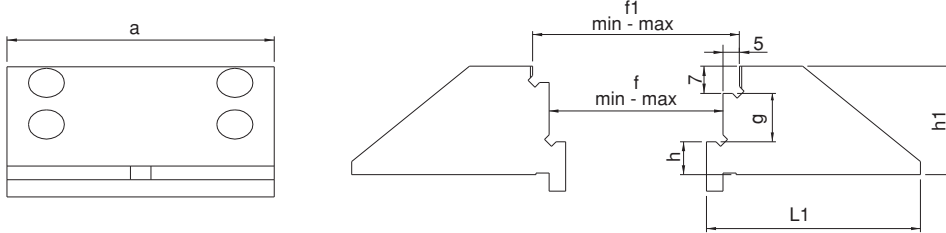

Nr.2310 ve Nr.2315 Kodlu Ürünlerle Uyumludur.

Referans Nr.	a	b	c
2310-23150606	60	23.5	45
2310-23150786	78	33	65
2310-23151006	100	35	77
2310-23151256	125	38	87
2310-23151576	157	46	104

Yumuşak Çene
Soft Jaw

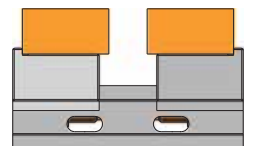
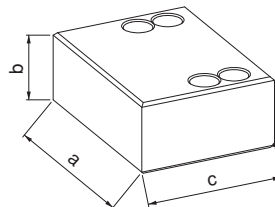

Nr.2310 ve Nr.2315 Kodlu Ürünlerle Uyumludur.

Referans Nr.
2310-2315-060AG
2310-2315078AG
2310-2315100AG
2310-2315125AG
2310-2315157AG

Alt Gövde
Sub-body

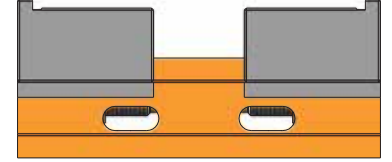

Referans Nr.
2310-2315060GÇ
2310-2315078GÇ
2310-2315100GÇ
2310-2315125GÇ
2310-2315157GÇ

Gezer Çene
Portable Jaw

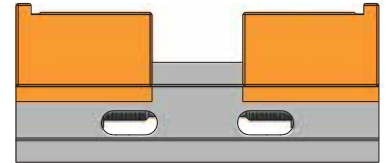

Referans Nr.
2310-2315060M
2310-2315078M
2310-2315100M
2310-2315125M
2310-2315157M

Mil
Pin

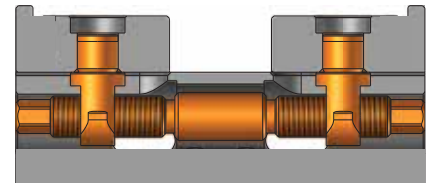

MENGENE UYGULAMALARI

VICE APPLICATIONS

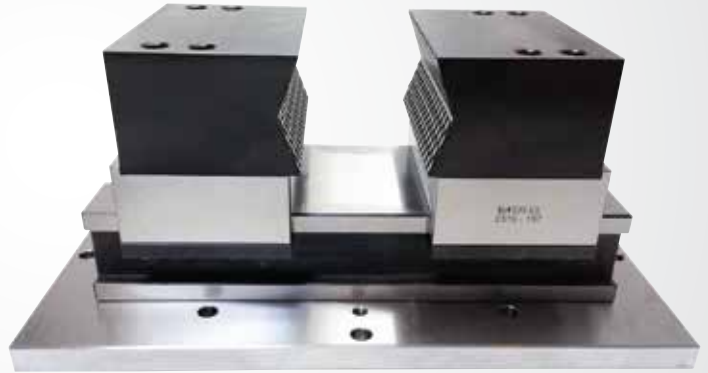
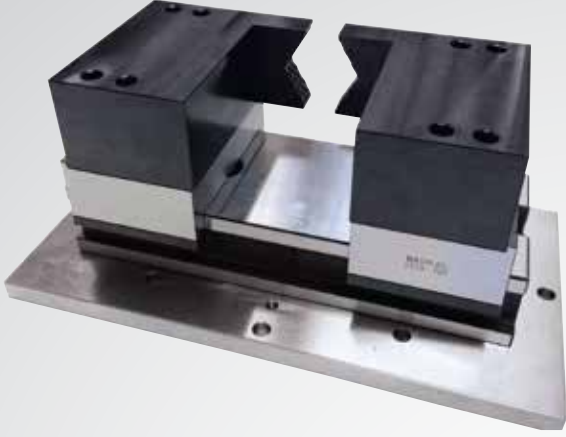

Referans Nr.	a	h	L	c	c1	c2	b	b1	b2	e	e1	i	d	Sıkma Kuvveti Clamping Force Kgf	Nm	sw	 (kg)
2315-046120	46	77	120	6-63	45-100	39-95	27	3	13	100	25	M5	52	600	30	12	3.00
2315-046160	46	77	160	6-103	45-140	39-135	27	3	13	100	25	M5	52	600	30	12	3.90
2315-077105	77	77	105	6-40	72-85	66-80	27	3	13	80	27	M6	52	1400	70	12	3.30
2315-077130	77	77	130	6-65	72-110	66-105	27	3	13	100	27	M6	52	1400	70	12	3.50
2315-077160	77	77	160	6-95	72-140	66-135	27	3	13	100	27	M6	52	1400	70	12	4.40
2315-077180	77	77	180	6-115	72-160	66-155	27	3	13	100	27	M6	52	1400	70	12	4.80
2315-077210	77	77	210	6-145	72-190	66-185	27	3	13	100	27	M6	52	1400	70	12	5.50
2315-097105	97	77	105	6-40	72-85	66-80	27	3	13	80	27	M6	52	1400	70	12	6.50
2315-097130	97	77	130	6-65	72-110	66-105	27	3	13	100	27	M6	52	1400	70	12	6.70
2315-097160	97	77	160	6-95	72-140	66-135	27	3	13	100	27	M6	52	1400	70	12	7.60
2315-097180	97	77	180	6-115	72-160	66-155	27	3	13	100	27	M6	52	1400	70	12	8.00
2315-097210	97	77	210	6-145	72-190	66-185	27	3	13	100	27	M6	52	1400	70	12	8.70
2315-125160	125	92	160	6-70	92-138	86-130	32	3	13	100	35	M8	96	2000	100	14	9.50
2315-125210	125	92	210	6-120	92-188	86-180	32	3	13	100	35	M8	96	2000	100	14	11.50
2315-125260	125	92	260	6-170	92-238	86-230	32	3	13	150	35	M8	96	2000	100	14	13.70
2315-125310	125	92	310	6-220	92-288	86-280	32	3	13	150	35	M8	96	2000	100	14	15.80
2315-125360	125	92	360	6-270	92-338	86-330	32	3	13	150	35	M8	96	2000	100	14	17.50

Ürün Nr. 2315 5-Eksen Mengene

- Ürün işlem yapılacak malzemeyi sabitlerken aynı zamanda da merkezleme yapmaktadır. Bu sistemin avantajı özellikle dış çap ölçüleri değişken malzemelerde merkez değişmeden işlem yapılabilir.
- Kullanım alanı: CNC ve CNC 5-Eksen sanayi makinelerinde kullanılır.
- Hareketli yüzeylerin tamamı hassas taşlanmış ve sertleştirilmiştir.
- Çeneleri ayrı olarak satın almanız gerekir.
- Siyah Kaplama

Product Nr. 2315 5-Axis Vice

- This product fixes the material to be processes and at the same time it makes centering. The advantage of this system specially shows itself when making machinings of the materials having different outer diameter measurements as it implements this process without changing the center.
- Area of Using: This product is used in various industry machines such as CNC and CNC 5-Axis mechanical milling machines,
- Entire moving surface is sensitively grinded and hardened.
- You need to purchase jaws separate.
- Black coating

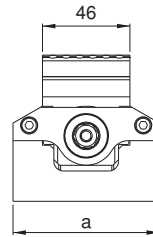
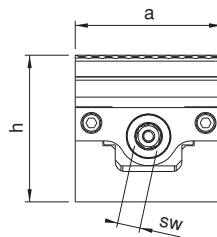
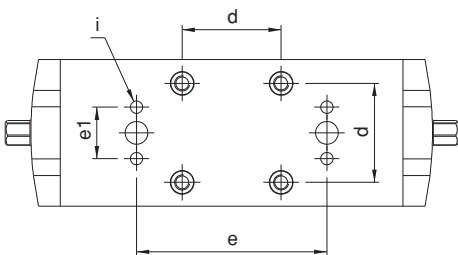
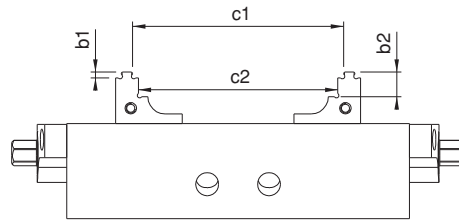
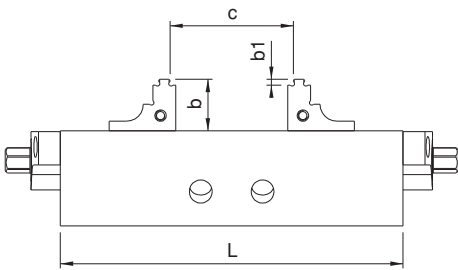
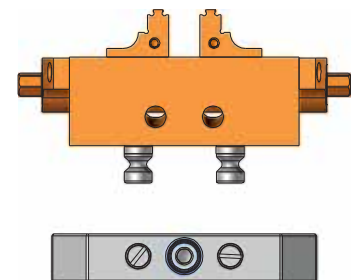

 Nr.2315-046120
 Nr.2315-046160

Referans Nr.	a	L	h	b	b1	b2	c	sw	d	Nm	(kg)
2315-052	116	150	27	100	50	-	52	8	12	13	2.9
2315-096	156	192	27	150	50	100	96	8	12	13	5.5

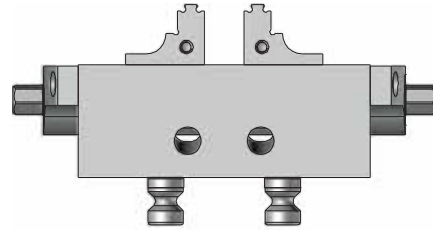
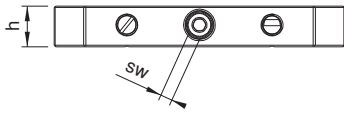
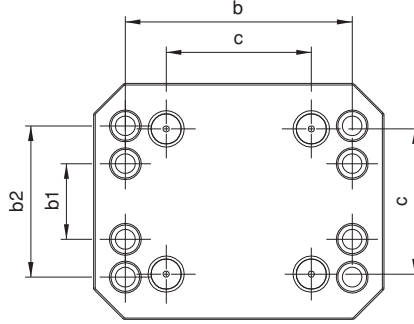
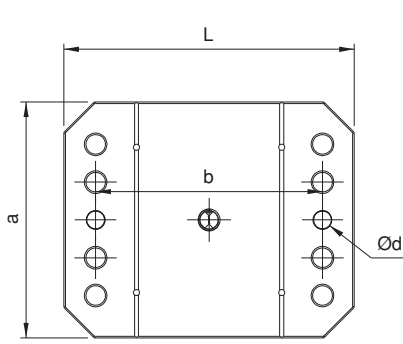

Ürün Nr. 2316 ER-EL Point Clamp

Product Nr. 2316 ER-EL Point Clamp



Çektirme Civatası

Pull Stud

Referans Nr.	m	h	h1	d	d1	(g)
2315-08	M8	20	5	12	16	35
2315-10	M10	20	5	16	20	50



Ürün Nr. 2316 Çektirme Civatası

Product Nr. 2316 Pull Stud

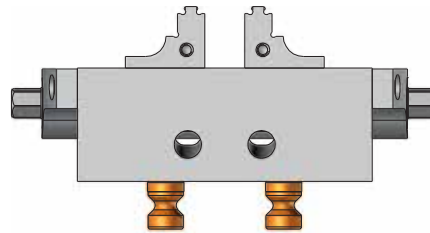
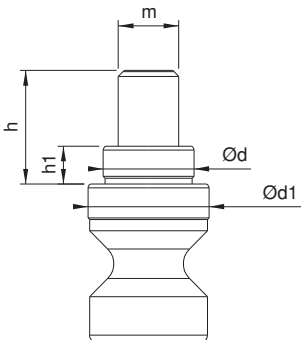

Referans Nr.	a	a1	h	L	c	c1	b	e	d	Sıkma Kuvveti Clamping Force Kgf	Nm	sw	 (kg)
2315-100160	100	125	175	220	10-160	7	22	200	96	2500	150	14	13.70
2315-130225	130	155	175	285	10-225	7	22	250	96	2500	150	14	20.50

Ürün Nr. 2315 Yüksek 5-Eksen Mengene

- Ürün işlem yapılacak malzemeyi sabitlerken aynı zamanda da merkezleme yapmaktadır. Bu sistemin avantajı özellikle dış çap ölçüleri değişken malzemelerde merkez değişmeden işlem yapılabilir.
- Kullanım alanı: CNC ve CNC 5-Eksen sanayi makinalarında kullanılır.
- Hareketli yüzeylerin tamamı hassas taşlanmış ve sertleştirilmiştir.
- Çeneleri ayrı olarak satın almanız gerekir.
- Siyah Kaplama

Product Nr. 2315 High 5-Axis Vice

- This product fixes the material to be processes and at the same time it makes centering. The advantage of this system specially shows itself when making machinings of the materials having different outer diameter measurements as it implements this process without changing the center.
- Area of Using: This product is used in various industry machines such as CNC and CNC 5-Axis mechanical milling machines,
- Entire moving surface is sensitively grinded and hardened.
- You need to purchase jaws separate.
- Black coating

NEW

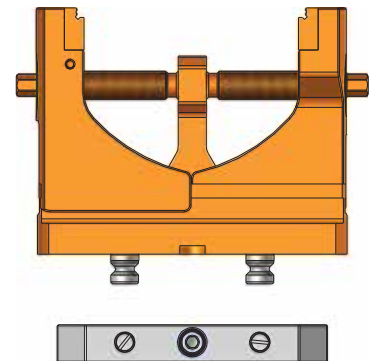
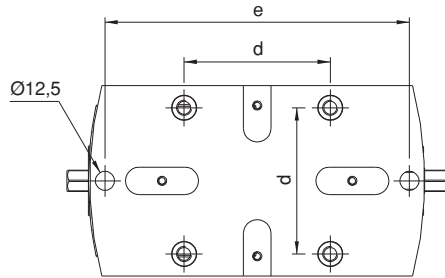
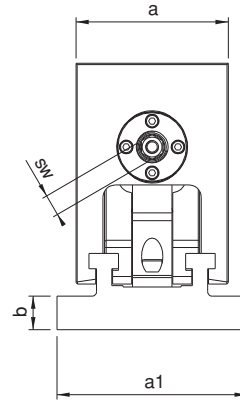
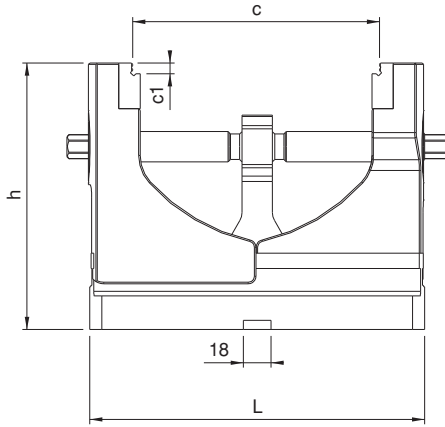

Referans Nr.	b	Sıkma Kuvveti Clamping Force kgf	 (kg)
2320-160200	0-200	4500	60

Ürün Nr. 2320 Hidrolik Mengene

- Kullanım alanı: CNC ve mekanik frezeler, matkap tezgahları, çeşitli sanayi makineleri.
- Hareketli yüzeylerin tamamı hassas taşlanmış ve sertleştirilmiştir.

Product Nr. 2320 Hydraulic Vice

- Area of Using: CNC and mechanical milling machines, drilling machines, various industrial machines
- Entire moving surface is sensitively grinded and hardened.

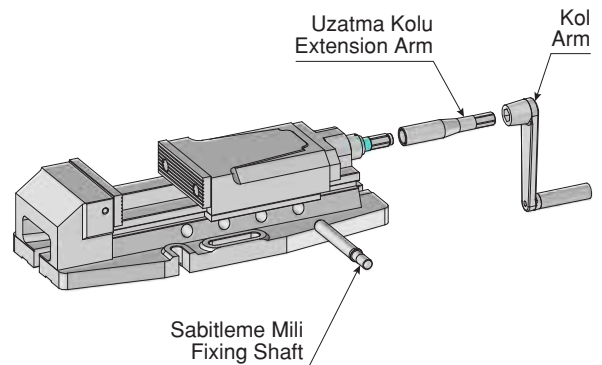
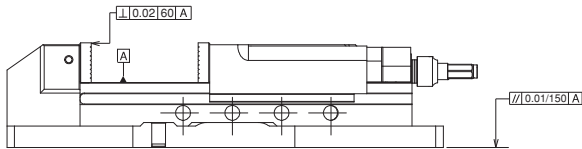
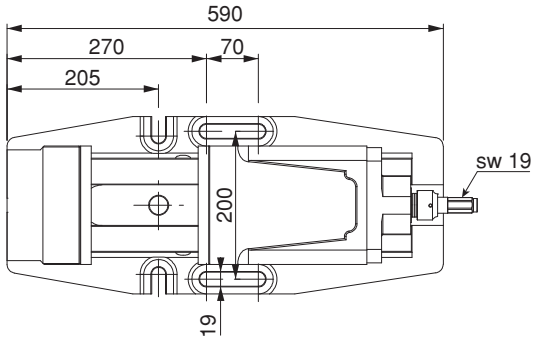
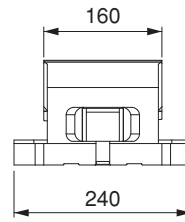
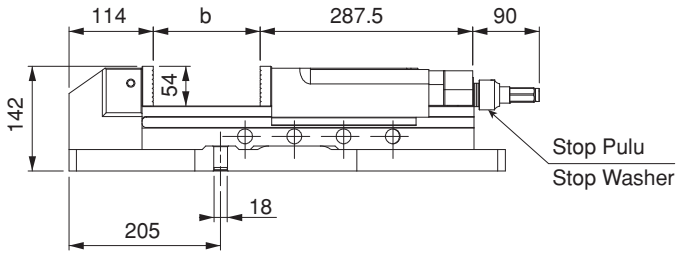
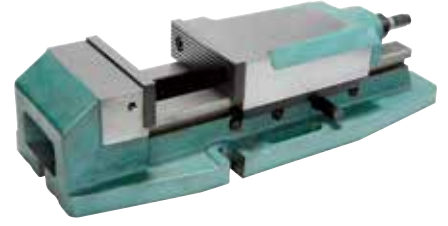

Referans Nr.	a	b	c	L	d	e	f	h	i	n	s	Sıkma Kuvveti Clamping Force kgf	Tork Değeri Allowable Screw Torque (N-m)	 (kg)
2330-127160	127	0-160	60	422	99	78	160	115	125	55	200	4500	170	28
2330-157200	157	0-200	60	462	99	78	160	115	150	55	200	4500	170	46
2330-157300	157	0-300	60	562	99	78	160	115	150	55	250	4500	170	51
2330-197300	197	0-300	60	562	99	78	160	115	150	55	250	4500	170	66
2330-197400	197	0-400	60	662	99	78	160	115	150	55	350	4500	170	73
2330-197500	197	0-500	60	762	99	78	160	115	150	55	250/250	4500	170	80



Ürün Nr. 2330 Mekanik Çelik Mengene

- Mekanik çelik mengene sertleştirilmiş ve hassas taşlanmış olarak mükemmel kullanıma sahiptir. Kullanım özelliği işlenecek malzemeyi sabitlerken sabit ve hareketli çenelerde bulunan modüler çeneler yaylı sisteminden dolayı malzemeyi mengene tabanına doğru çeker ve güvenli çalışma sağlar. Kamalı sabitleme özelliğiyle hareketli çene mesafesi hızlı ayarlanabilir, kolay kullanılır.
- Kullanım alanı: CNC ve mekanik frezeler, taşlama ve matkap tezgahları, çeşitli sanayi makineleri
- Hareketli yüzeylerin tamamı hassas taşlanmış ve sertleştirilmiştir.

Product Nr. 2330 Mechanical Steel Vice

- Mechanical Steel Vice is hardened and it has excellent way of using because of being sensitively grinded. It's usage characteristic fixes the material to be machined and at the same time it pulls the material to the base of the vice because of having springed system of modular jaws taking place in the moving jaws. Entire moving surface is sensitively grinded. With it's wedged fixing characteristic, moving jaw distance can be adjusted rapidly and can be used with convenience.
- Area of Using: CNC and mechanical milling machines, grinding and drilling machines, various industrial machines
- Entire moving surface is sensitively grinded and hardened.

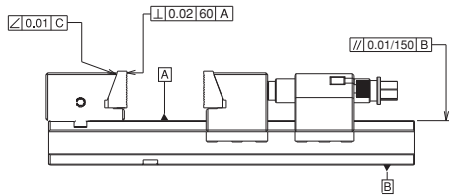
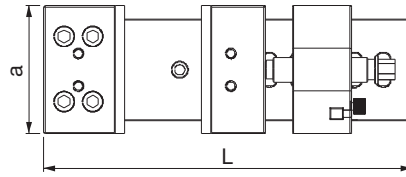
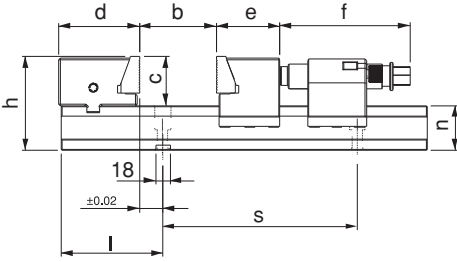



2'li Bağlama İçin Ara Vasat

Medium Part to Connect Two Work Piece

Referans Nr.	b1	 (kg)
2330-127	50	3.1
2330-157	50	3.8
2330-197	50	4.7

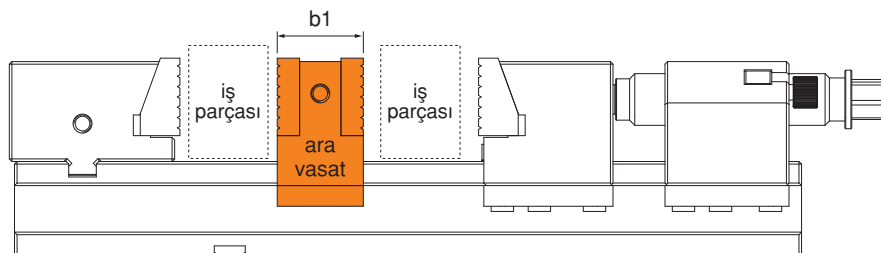
Not: Çoklu bağlamalar için aravasat
Notes: To be able to clamp several workpieces,
intermediate pieces are required.



Referans Nr.	a	L	L1	b1	b	c	h	ı	n	Ød	sıkma kuvveti clamping force kgf	Tork Değeri Allowable Screw Torque (N-m)	 (kg)
2345-127	127	202	260	53	0-58	60	115	163.5	55	12.5	4500	170	28

Ürün Nr. 2345 Modüler Mekanik Çelik Mengene

- Ürün çenelerinin hareketli oluşu iş parçasını karşıya ve aşağıya çekerek sıkar. Mengenenin iki parçalı ve paralel oluşu büyük iş parçalarını bağlamada delik diş vs. gibi işlemlerde kolaylık sağlar.
- Hareketli yüzeylerin tamamı hassas taşlanmış ve sertleştirilmiştir.

Product Nr. 2345 Modular Mechanical Steel Vice

- Because of sliding clamping jaws it clamps the workpieces in opposite direction and down. The vice consists of two parts and it is parallel which provides clamping big tools, threading and similar processes easy.
- Entire moving surface is sensitively grinded and hardened.

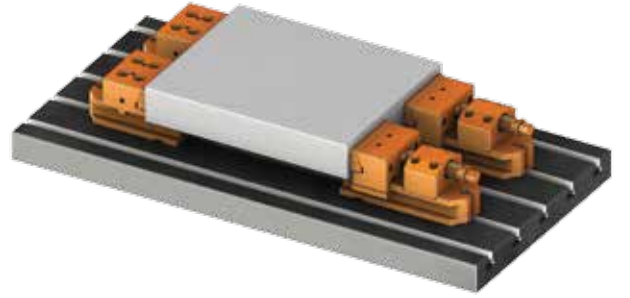
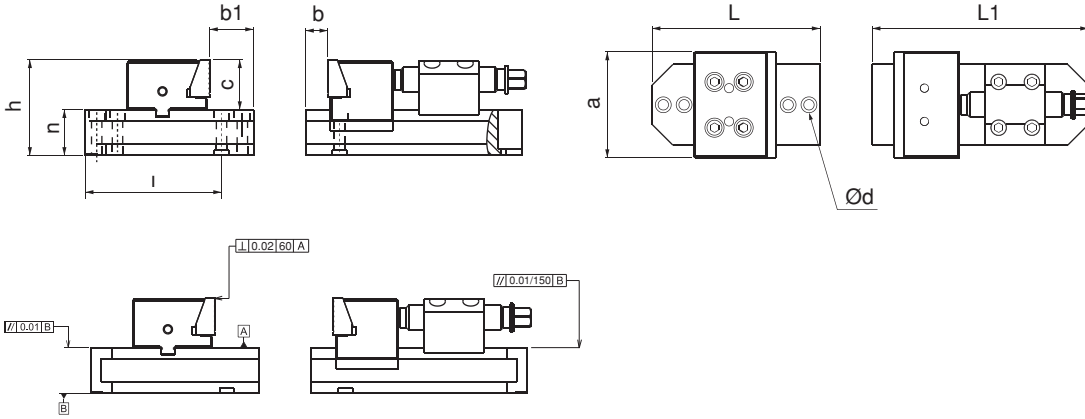

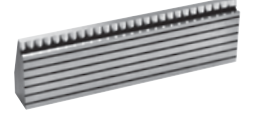
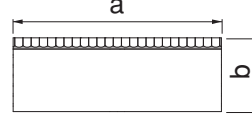
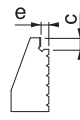

Referans Nr.	a	b	c	d	e	f	
2333-127	127	45	7	-	5	-	760
2333-157	157	45	7	-	5	-	935
2333-197	197	45	7	-	5	-	1180

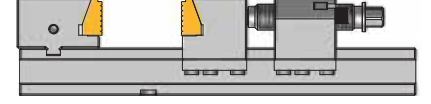

Ürün Nr. 2333 Mekanik Çelik Mengene Faturalı Çene
Product Nr. 2333 Mechanical Steel Vice Jaws with Stopper

- Sertleştirilmiş
- Hardened



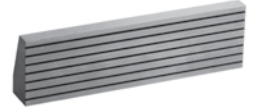
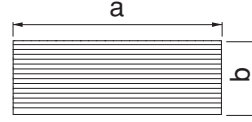

Referans Nr.	a	b	c	d	e	f	
2334-127	127	45	-	-	-	-	765
2334-157	157	45	-	-	-	-	960
2334-197	197	45	-	-	-	-	1185

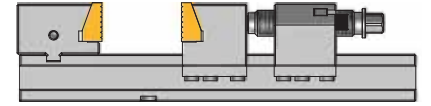

Ürün Nr. 2334 Mekanik Çelik Mengene Düz Çene
Product Nr. 2334 Mechanical Steel Vice with Straight Jaw

- Sertleştirilmiş
- Hardened



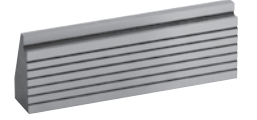
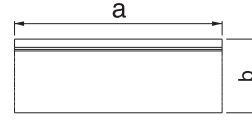
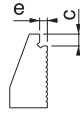

Referans Nr.	a	b	c	d	e	f	
2335-127	127	45	7	-	5	-	760
2335-157	157	45	7	-	5	-	935
2335-197	197	45	7	-	5	-	1180

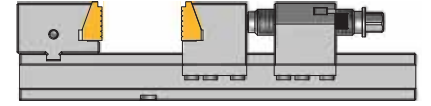

Ürün Nr. 2335 Mekanik Çelik Mengene Faturalı Çene
Product Nr. 2335 Mechanical Steel Vice Jaws with Stopper

- Sertleştirilmiş
- Hardened



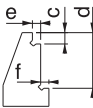

Referans Nr.	a	b	c	d	e	f	
2340-127	127	45	7	34	5	5	950
2340-157	157	45	7	34	5	5	1010
2340-197	197	45	7	34	5	5	1290

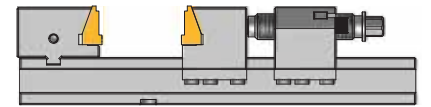

Ürün Nr. 2340 Mekanik Çelik Mengene Faturalı Çene
Product Nr. 2340 Mechanical Steel Vice Jaws with Stopper

- Sertleştirilmiş
- Hardened



Referans Nr.	a	b	c	d	e	f	
2336-127	127	45	7	34	5	5	950
2336-157	157	45	7	34	5	5	1010
2336-197	197	45	7	34	5	5	1290

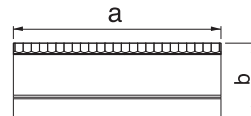
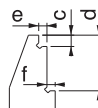

Ürün Nr. 2340 Mekanik Çelik Mengene Faturalı Çene
Product Nr. 2340 Mechanical Steel Vice Jaws with Stopper

- Sertleştirilmiş
- Hardened

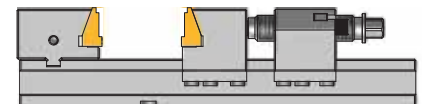

Referans Nr.
2330-127160AG
2330-157200AG
2330-157300AG
2330-197300AG
2330-197400AG
2330-197500AG

Ürün Nr. 2330 Alt Gövde
Product Nr. 2330 Sub-body

Not: Çoklu bağlamalar için aravasat
Notes: To be able to clamp several workpieces, intermediate pieces are required.

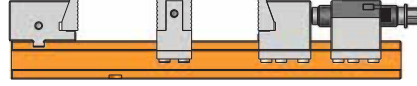

Referans Nr.
2330-127SÇ
2330-157SÇ
2330-197SÇ

Ürün Nr. 2330 Sabit Çene
Product Nr. 2330 Fixed Jaw

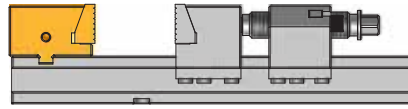

Referans Nr.
2330-127GÇ
2330-157GÇ
2330-197GÇ

Ürün Nr. 2330 Gezer Çene
Product Nr. 2330 Portable Jaw

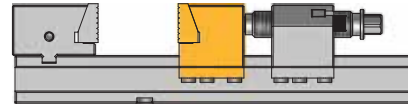

Referans Nr.
2330-127GS
2330-157GS
2330-197GS

Ürün Nr. 2330 Gezer Somun
Product Nr. 2330 Portable nut

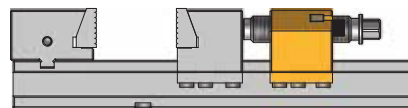

Referans Nr.
2330-127SK
2330-157SK
2330-197SK

Ürün Nr. 2330 Stop Kaması
Product Nr. 2330 Wedge of Stop

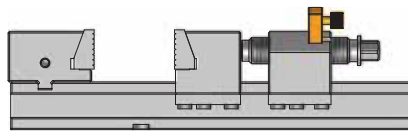

Referans Nr.
2330-127157197M

Ürün Nr. 2330 Mil
Product Nr. 2330 Pin

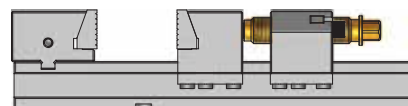

Referans
Nr.

2345-127SAG

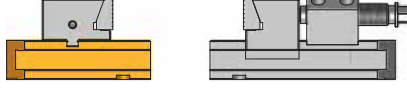
Ürün Nr. 2345 Sabit Alt Gövde
Product Nr. 2345 Fixed Sub-bodyReferans
Nr.

2345-127GAG

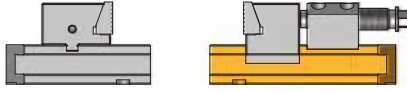
Ürün Nr. 2345 Gezer Alt Gövde
Product Nr. 2345 Portable Sub-bodyReferans
Nr.

2345-127SÇ

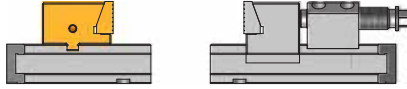
Ürün Nr. 2345 Sabit Çene
Product Nr. 2345 Fixed JawReferans
Nr.

2345-127GÇ

Ürün Nr. 2345 Gezer Çene
Product Nr. 2345 Portable JawReferans
Nr.

2345-127SS

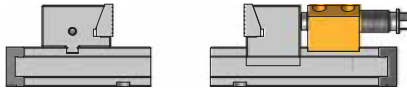
Ürün Nr. 2345 Sabit Somun
Product Nr. 2345 Fixed NutReferans
Nr.

2330-127157197M

Ürün Nr. 2330 Mil
Product Nr. 2330 Pin

Referans Nr.	a	b	c	k	L	d	e	h	i	n ±0.01	sıkma kuvveti clamping force kgf	hareket mesafesi Moving Distance Torque	(kg)
2350-160E	160	160	58	310	530	130	145	160	190	105	2000	4	62

Ürün Nr. 2350 Pnömatik Mengene 160E

- 6 Bar hava ile çalışır. Pnömatik yapısından dolayı sıkma-açma işlemlerinde hız kazandırır.
- 2000 kgf sıkma kuvvetiyle iş parçasını sabitler. İsteğe bağlı bar ayar butonuyla sıkma kuvveti ayarlanabilir.
- Kullanım alanı: CNC ve mekanik frezeler, matkap tezgahları, çeşitli sanayi makineleri.
- Hareketli yüzeylerin tamamı hassas taşlanmış ve sertleştirilmiştir.

Product Nr. 2350 Pneumatic Vice 160E

- It works with 6 Bar Air. It provides speed in clamping-opening processes because of it's pneumatic structure.
- It fixes the workpiece with it's 2000 kgf clamping force. Clamping force can be adjusted with it arbitrary bar adjustment button.
- Area of Using: CNC and mechanical milling machines, drilling machines, various industrial machines
- Entire moving surface is sensitively grinded and hardened.

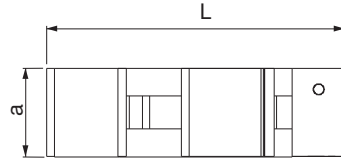
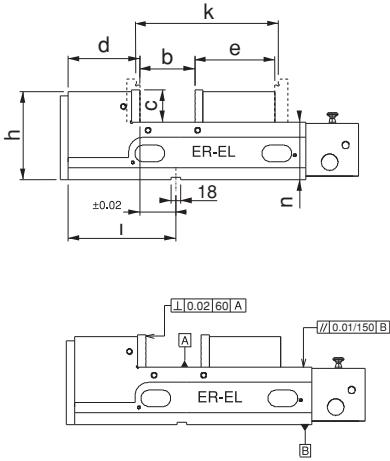

- "k" ölçüsüne yedek çenelerle ulaşılır. Yedek çeneler takıma dahil değildir.
- "k" measurement is reached by the spare jaws. The spare jaws are not included in the set.



Referans Nr.	a	a1	b	c	k	L	d	e	h	i	n ±0.01	sıkma kuvveti clamping force kgf	hareket mesafesi Moving Distance Torque	(kg)
2370-051	130	188	60	58	135	327	64	209	160	-	105	1100	4	37
2370-052	130	185	140	63	225	400	69	300	160	173	105	2200	4	44
2370-053	160	201	200	63	300	485	93	353	166	170	105	3300	4	63
2370-054	200	240	250	63	360	530	93	410	166	185	105	4100	4	81

Ürün Nr. 2370 Pnömatik Mengene B

- 6 Bar hava ile çalışır. Pnömatik yapısından dolayı sıkma-açma işlemlerinde hız kazandırır.
- 1100 kgf ile 4100 kgf sıkma kuvvetiyle iş parçasını sabitler. İsteğe bağlı bar ayar butonuyla sıkma kuvveti ayarlanabilir.
- Kullanım alanı: CNC ve mekanik frezeler, matkap tezgahları, çeşitli sanayi makineleri.
- Hareketli yüzeylerin tamamı hassas taşlanmış ve sertleştirilmiştir.

Product Nr. 2370 Pneumatic Vice B

- It works with 6 Bar Air. It provides speed in clamping-opening processes because of it's pneumatic structure.
- It fixes the workpiece with it's 1100 kgf and 4100 kgf clamping force. Clamping force can be adjusted with it arbitrary bar adjustment button.
- Area of Using: CNC and mechanical milling machines, drilling machines, various industrial machines
- Entire moving surface is sensitively grinded and hardened.

Pnömatik Mengene

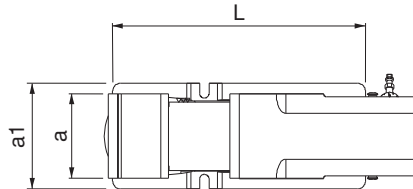
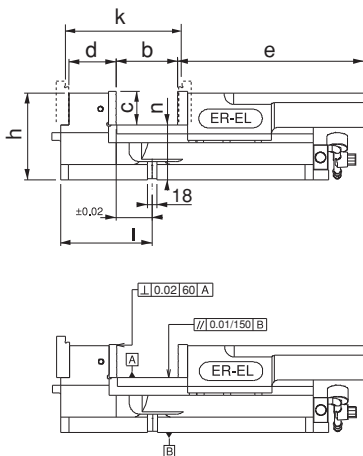

Pneumatic Vice

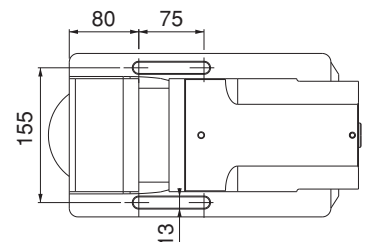

- "k" ölçüsüne yedek çenelerle ulaşılır. Yedek çeneler takıma dahil değildir.
- "k" measurement is reached by the spare jaws. The spare jaws are not included in the set.

2370-051 Detay / Detail



Referans Nr.		H min. - max.	L	ØD	S min. - max.	B	M	
2377-12512	12	85-125	90	6	30-50	37	M10	780
2377-12514	14	85-125	90	6	30-50	37	M10	780
2377-12516	16	85-125	90	6	30-50	37	M10	780
2377-12518	18	85-125	90	6	30-50	37	M10	780
2377-16512	12	85-165	90	6	95-50	37	M10	865
2377-16514	14	85-165	90	6	95-50	37	M10	865
2377-16516	16	85-165	90	6	95-50	37	M10	865
2377-16518	18	85-165	90	6	95-50	37	M10	865

Ürün Nr. 2377 5D Dayama

- 5 Eksen ayarlama özelliği ile makinalarda ve montaj çalışmalarında hızlı ve esnek şekilde kolay kullanım olanağı sağlar.

Ürün Nr. 2377 5D Pluggable

- With its 5 axis adjustment feature, it provides fast and flexible usage in machines and assembly works.

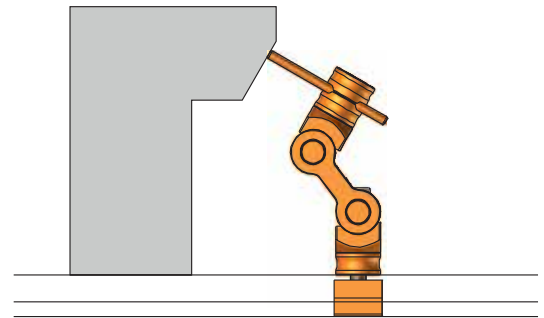
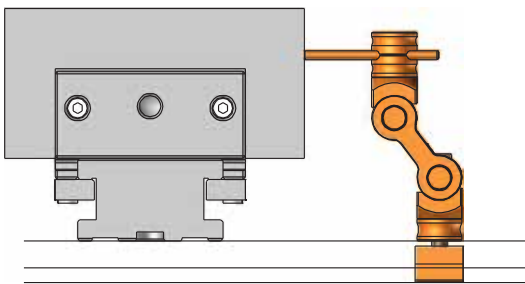
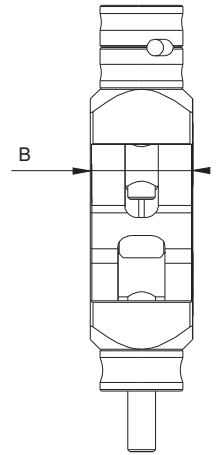
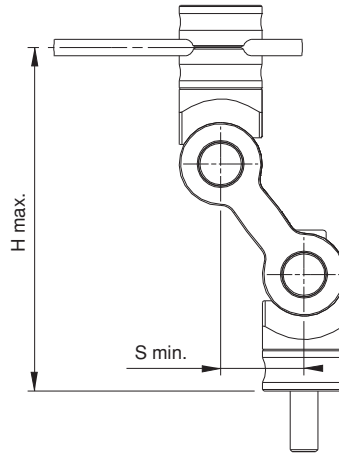
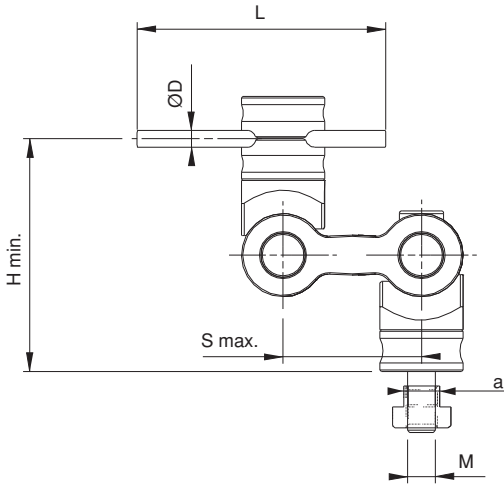
Uygulama Örnekleri / Example Application

HİDROLİK FİKSTÜR UYGULAMALARI

HYDRAULIC FIXTURE APPLICATION



Referans Nr.	d	d1	h	h1	L	(kg)
2385-130	48	32	91	60	151	3.05

Ürün Nr. 2385 Hassas Delik İşleme Aparatı

- Ürün 0.01 işleme hassasiyetli olup 9mm'den 130mm çapa 145 mm derinliğe işlem yapabilir değiştirilebilir bara ve kartuş özelliği ile mükemmel kullanıma sahiptir.

Product Nr. 2385 Precision Hole Making Tool

- It works with 0.01 sensitivity in diameter 9-130 mm and 145 mm depth. Because of replaceable function kater and cartouche it is perfect in using.

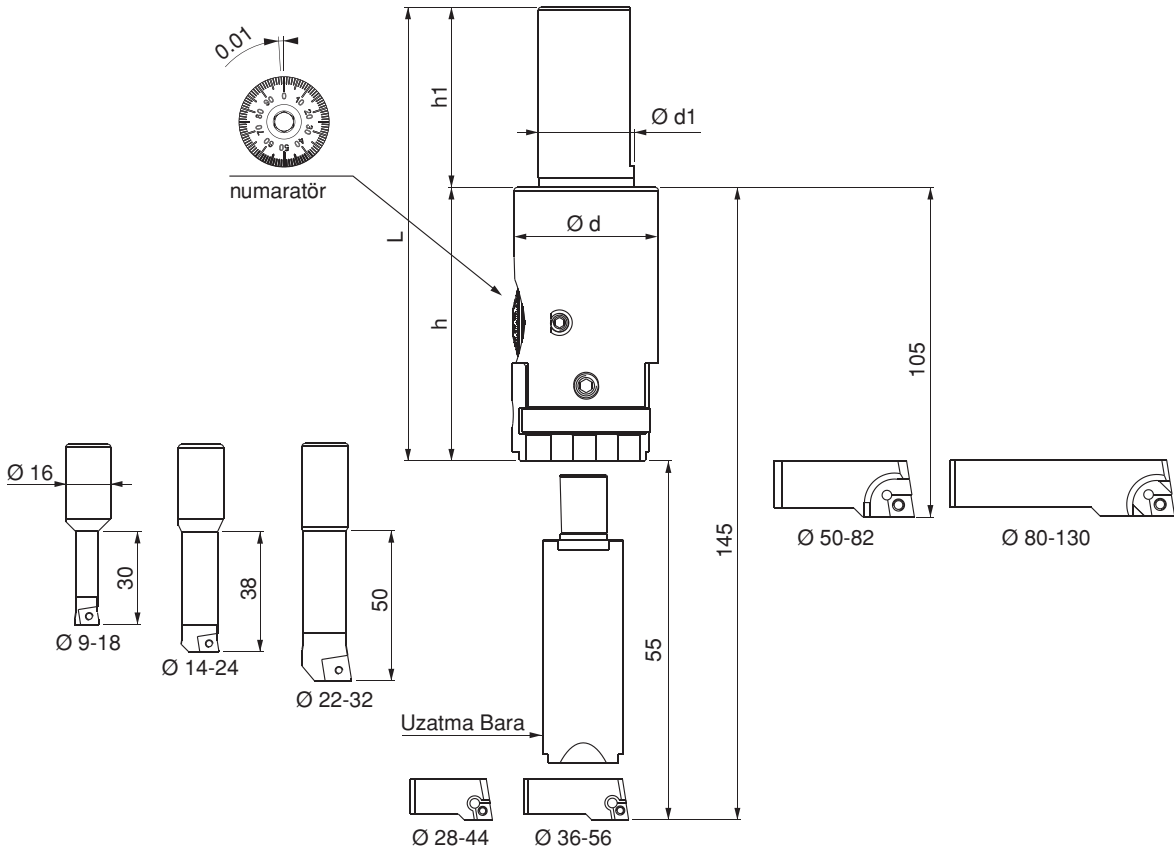

Not:
Ø 52 den sonra
gövdeyle 105 mm
uzatma barayla
145 mm
derinliğe ulaşır.

Note; from diameter 52: It reaches 105 mm depth with its slot and 145 mm depth with its extended kater

Referans Nr.	Cinsi Type	Uç Tipi Type of Inserts	Devir Rotation	İlerleme Progress	ap
2386-00918	09-18 Bara	CCMT 06	2700 d/dk.	F 75	0.1 - 0.5 mm
2386-01424	14-24 Bara	CCMT 06	2500 d/dk.	F 75	0.1 - 0.5 mm
2386-02232	22-32 Bara	CCMT 09	2000 d/dk.	F 50	0.1 - 1 mm
2386-02844	28-44 Kartuş	CCMT 06	1800 d/dk.	F 60	0.1 - 1 mm
2386-03656	36-56 Kartuş	CCMT 06	1500 d/dk.	F 65	0.1 - 1.5 mm
2386-05082	50-82 Kartuş	CCMT 09	1500 d/dk.	F 70	0.1 - 2 mm
2386-80130	80-130 Kartuş	CCMT 09	360 d/dk.	F 75	2 mm
2386-00055	Uzatma Bara	-	400 d/dk.	F 75	1.5 mm

Referans Nr.	J x M	k	h	h1	e	L	L1	L2	(g)
2390-010	ISO30-M12	83	99	35	18	95	128	26	6030
2390-015	ISO40-M16								6555
2390-020	ISO50-M24								9110
2390-025	BT40 - M16								6900
2390-030	BT50 - M24								9840
2390-035	SK40- M16								6750
2390-040	SK50- M24								8970
2390-045	MK4 - M16								6180
2390-050	MK4 Kamalı								6880
2390-055	MK5 - M20								7785
2390-060	MK5 Kamalı	7450							

Ürün Nr. 2390 Delik İşleme Aparatı

- Ürün 0.02 işleme hassasiyetli olup 18mm'den 210mm'ye kadar işlem yapabilir.
- Modüler sistem oluşu kullanım için kolaylık sağlar.
- Tutucu değiştirilerek CNC ve Mekanik tezgahlarda kullanım avantajı sağlar.
- Ürün, 4 ad. delik barası, 1 ad. T-Kanal temizleyici ile ahşap kutudadır.
- Değiştirilebilir Tutucular:
- ISO-30-40-50 BT40-50 SK40-50 MK4-5 ile kullanım imkanı.

Product Nr. 2390 Hole Machining Apparatus

- Product has 0.02 machining sensitivity and it can implement processes from 18mm to 210mm.
- It's modular system structure provides convenience in using.
- It provides the possibility of using in CNC and Mechanical benches by changing the holder.
- The product takes place in a wooden box with it's 4 hole bar, 1 T-Slot scraper.
- Changeable Holders:
- Possibility to be used with ISO30-40-50 BT 40-50 SK40-50 MK4-5.

Modülerdir, sabitleme işlemi saat yönüne doğru vidalanarak yapılır.
It is modular. Fixing process is done screwing towards clockwise

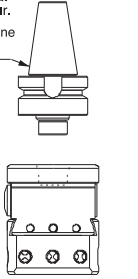

Referans Nr.	L	L1	e	Kesici uç tipi Cutting Edge type	(g)
2395-1	85	-	18	DCMT	112
2395-2	95	-	18	DCMT	130
2395-3	132	-	18	DCMT	200
2395-4	-	128	18	-	360

min	Ø	max	c1	devir dk. Revolution per minute
18		95	50	400-450
18		95	63	400-450
20		100	100	170-220

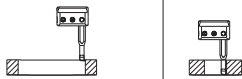

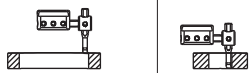

- Ürünün kazağındaki alt deliklerine baraları takarak 18mm'den 100mm çapa kadar büyütme 0-100mm kadar derinliğe inebilir.
- It is possible to have enlargement from 18mm to 100mm by attaching bars to the bottom holes taking place in the slide of the product and it can go down to depth up to 0-100mm.

min	Ø	max	c2	devir dk. Revolution per minute
95		210	55	90-170
95		210	65	90-170

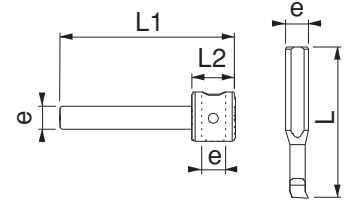
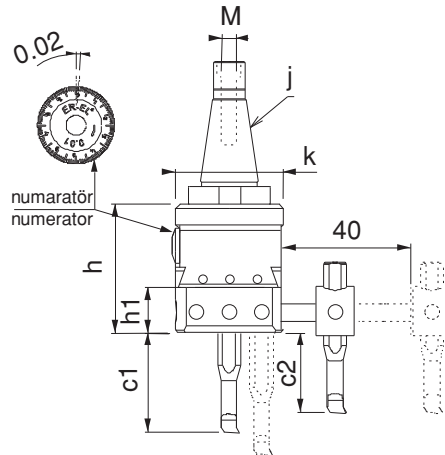

- Ürünün kazağındaki yan deliğe ara vasatı takarak, şekilde görüldüğü gibi 95mm'den - 210mm çapa kadar büyütme, 0-65mm kadar derinliğe inebilir
- By applying intermediary means to the side hole of the product's slide, it is possible to have enlargement from 95mm to 210mm and it can go down to depth up to 0-65mm as seen in the figure.



Referans Nr.	ISO	d	d1	L	L1	m	
2410-3016	ISO 30	16	48	125	17	M12	665
2410-3022	ISO 30	22	48	125	19	M12	760
2410-3027	ISO 30	27	48	125	21	M12	790
2410-3032	ISO 30	32	63.5	125	22	M12	1020
2410-4016	ISO 40	16	63.5	153	17	M16	1170
2410-4027	ISO 40	27	63.5	153	19	M16	1360
2410-4032	ISO 40	32	63.5	153	24	M16	1605
2410-4040	ISO 40	40	73.5	153	27	M16	1795
2410-5016	ISO 50	16	98	195	17	M24	3250
2410-5022	ISO 50	22	98	195	19	M24	3350
2410-5027	ISO 50	27	98	195	21	M24	3400
2410-5032	ISO 50	32	98	195	24	M24	3590
2410-5040	ISO 50	40	98	195	27	M24	3750

Ürün Nr. 2410 ISO 30-40-50
Freze Tarama Kafa Tutucusu

- Sertleştirilmiş
- Hassas taşlama

Product Nr. 2410 ISO 30-40-50
Milling Machine Hatching Headpiece Holder

- Hardened
- Sensitive Grinding

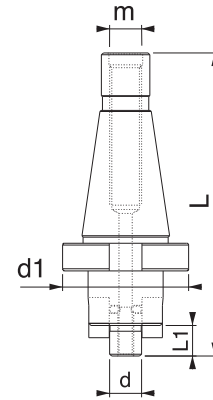

Freze Tarama Başlığı Tutucusu

Milling Machine Hatching Headpiece Holder

Referans Nr.	MK	d	d1	L	L1	m	
2415-0416	MK 4	16	40	168	17	M16	945
2415-0422	MK 4	22	48	168	19	M16	1010
2415-0427	MK 4	27	53	168	21	M16	1135
2415-0432	MK 4	32	63.5	168	24	M16	1255
2415-0516	MK 5	16	63.5	208	17	M20	2145
2415-0522	MK 5	22	63.5	208	19	M20	2375
2415-0527	MK 5	27	63.5	208	21	M20	2360
2415-0532	MK 5	32	63.5	208	24	M20	2500
2415-0540	MK 5	40	73.5	208	27	M20	2700

Ürün Nr. 2415 MK4-MK5
Freze Tarama Kafa Tutucusu

- Sertleştirilmiş
- Hassas taşlama

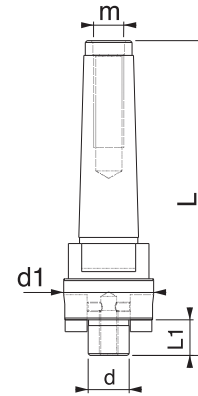

Product Nr. 2415 MK4-MK5
Milling Machine Hatching Headpiece Holder

- Hardened
- Sensitive Grinding



Freze Tarama Başlığı

Milling Machine Hatching Headpiece

Referans Nr.	d	h	d1	p	e		Kesici uç tipi Cutting Edge type	
2420-0403	40	44	16	8.5	16	3	TPKN	230
2420-0503	50	44	22	10.5	16	3	TPKN	310
2420-0633	63	44	22	10.5	16	3	TPKN	410
2420-0634	63	44	22	10.5	16	4	TPKN	480
2420-0804	80	52	32	14.5	22	4	TPKN	800
2420-1005	100	52	32	14.5	22	5	TPKN	1320

Ürün Nr. 2420 Freze Tarama Başlığı

- Sertleştirilmiş
- Siyah kaplama

Product Nr. 2420 Milling Machine Hatching Headpiece

- Hardened
- Black Coating

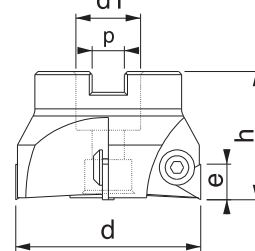

Referans Nr.	d	Metrik	Alyan Allen
2420-06	40-50-63	M6x0.75	4
2420-08	80-100	M8x1	5

Ürün Nr. 2420 Yedek Baskı Vidası

- Sertleştirilmiş
- Siyah kaplama

Product Nr. 2420 Spare Press Screw

- Hardened
- Black Coating



ÇOK ÇENELİ SERİ MENGENELER

MULTI JAWED WRENCH TOOLING

Çok Çeneli Seri Mengene Tek Yöne Sıkma Şekli

One Direction Clamping of Multi Jawed Wrench Tooling

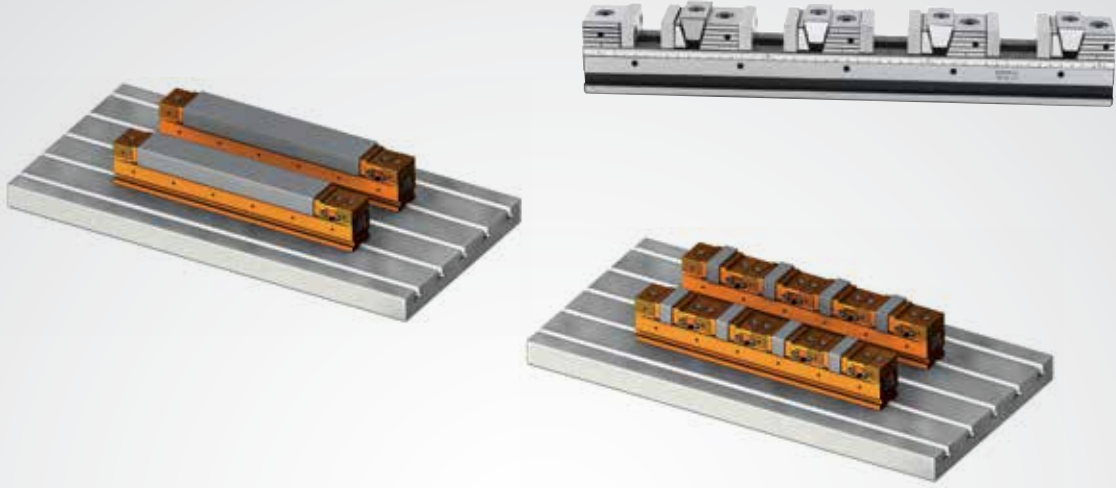

Çok Çeneli Seri Mengene Çift Yöne Sıkma Şekli

Two Direction Clamping of Multi Jawed Wrench Tooling

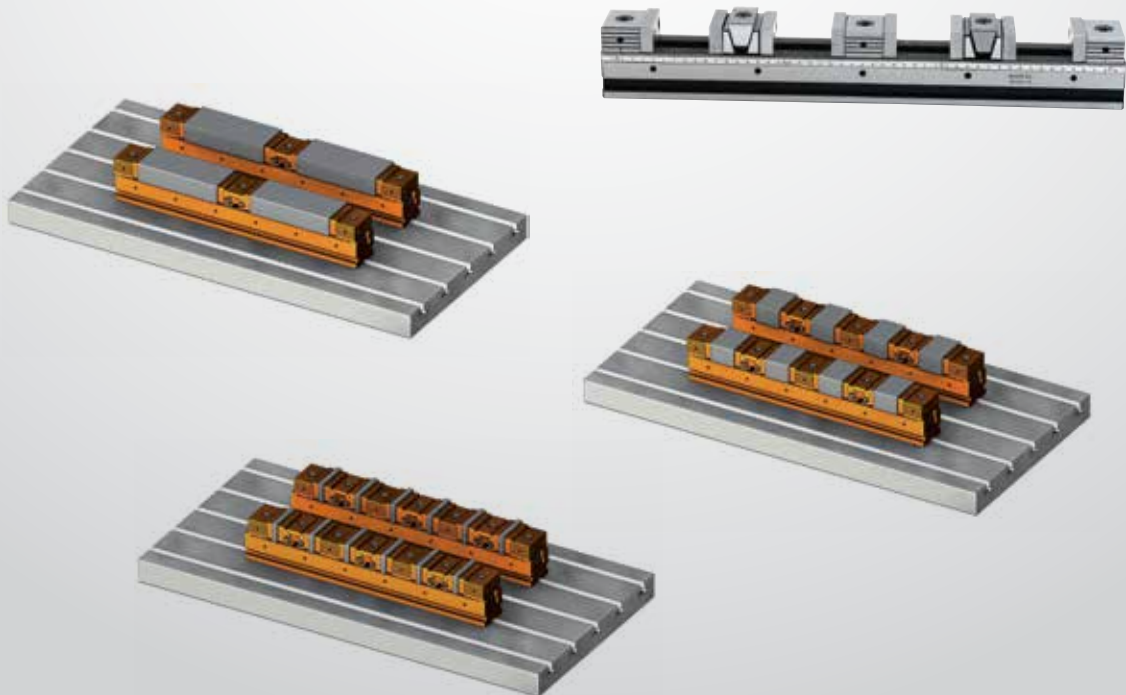

Referans Nr.	L	n	h1	h2	h	o	e	f	b	c	k	ı	p H7	Standart Bağlama Adedi Coupling Piece	Sıkma Kuvveti Clamping Force kgf	Tork Değeri Allowable Screw Torque (N-m)	(kg)
2430-055300	300	55	50	32	72	12.5	36	65	100	50	100	100	18	2	1750	25	9
2430-055500	500	55	50	32	72	12.5	36	65	100	50	100	300	18	4			15
2430-075400	400	75	65	37	102	12.5	48	77	100	50	100	200	18	2	2000	35	20
2430-075600	600	75	65	37	102	12.5	48	77	100	50	100	400	18	4			33
2430-100400	400	100	65	37	102	12.5	48	80	100	50	100	200	18	2	2500	50	27
2430-100600	600	100	65	37	102	12.5	48	80	100	50	100	400	18	3			41

Ürün Nr. 2430 Çok Çeneli Seri Mengene

- Ürüne birden fazla iş bağlama imkanı sağlar. Çeneler modülerdir, istenen ölçüye ayarlanır.
- Gruplara bağlanan yumuşak ayaklara iş parçası formu uygulanabilir.
- Hassas taşlama
- Çeneleri ayrı olarak satın almanız gerekir.



Product Nr. 2430 Multi Jawed Wrench Tooling

- It provides the attachments of more than one workpieces to the product. Jaws are modular and can be adjusted to the desired measurement.
- Form of the workpiece can be applied on the soft legs connected to the groups.
- Sensitive Grinding
- You need to purchase jaws separate.

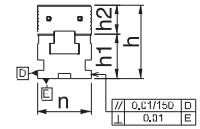
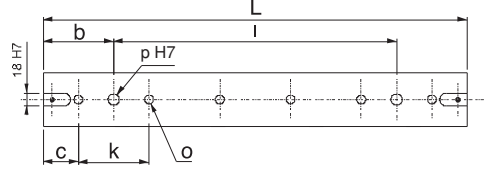
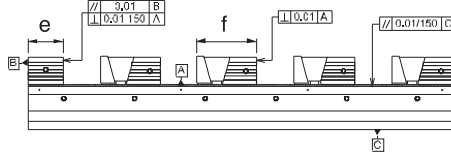

Referans Nr.	GEZER ÇENE İLE İŞ PARÇASI BAĞLAMA ADETLERİ / Numbers of Portable Jaw with Workpiece Couplings				
	1 İş parçası 1 Workpiece	2 İş parçası 2 Workpiece	3 İş parçası 3 Workpiece	4 İş parçası 4 Workpiece	5 İş parçası 5 Workpiece
2430-055300	196mm	65mm	22mm	-	-
2430-055500	394mm	165mm	88mm	50mm	26mm
2430-075400	268mm	95mm	38mm	-	-
2430-075600	472mm	197mm	106mm	60mm	32mm
2430-100400	265mm	93mm	35mm	-	-
2430-100600	469mm	195mm	103mm	57mm	30mm

Not: İş bağlama adetleri ölçülerinde yumuşak ayak dahil değildir.

Note: It does not include binding units of measure soft feet in business.



Referans Nr.	L	n	h1	h2	h	o	e	f	b	c	k	i	p H7	Standart Bağlama Adedi Coupling Piece	Sıkma Kuvveti Clamping Force Kgf	Tork Değeri Allowable Screw Torque (N-m)
2435-055300	300	55	50	32	82	12.5	32	37	100	50	100	100	18	2	1750	25
2435-055500	500	55	50	32	82	12.5	32	37	100	50	100	300	4			
2435-075400	400	75	65	37	102	12.5	37	57	100	50	100	200	18	2	2000	35
2435-075600	600	75	65	37	102	12.5	37	57	100	50	100	400	4			
2435-100400	400	100	65	37	102	12.5	37	57	100	50	100	200	18	2	2500	50
2435-100600	600	100	65	37	102	12.5	37	57	100	50	100	400	4			

Ürün Nr. 2435 Çok Çeneli Seri Mengene

- Çift açılır bağlama modelidir.
- Çeneleri ayrı olarak satın almanız gerekir.

Product Nr. 2435 Multi Jawed Wrench Tooling

- Double opening clamp model.
- You need to purchase jaws separate.

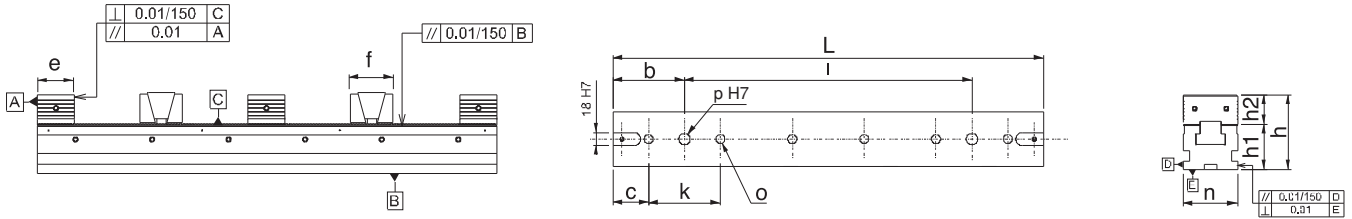

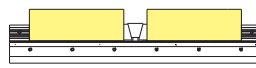
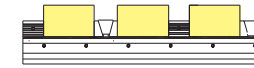
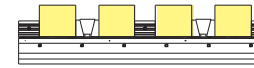
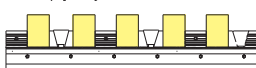
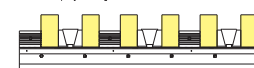
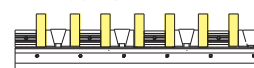
Referans Nr.	ÇİFT AÇILIR ÇENE İLE İŞ PARÇASI BAĞLAMA ADETLERİ / Numbers of Double Opening Jaw with Workpiece Couplings		
	2 İş parçası 2 Workpiece	3 İş parçası 3 Workpiece	4 İş parçası 4 Workpiece
2435-055300			
2435-055500	75mm	37mm	16mm
2435-075400	173mm	103mm	66mm
2435-075600	107mm	55mm	28mm
2435-100400	209mm	123mm	79mm
2435-100600	104mm	53mm	26mm
2435-100600	206mm	121mm	77mm
	5 İş parçası 5 Workpiece	6 İş parçası 6 Workpiece	7 İş parçası 7 Workpiece
			
2435-055300	-	-	-
2435-055500	45mm	30mm	20mm
2435-075400	13mm	-	-
2435-075600	54mm	45mm	24mm
2435-100400	12mm	-	-
2435-100600	52mm	34mm	22mm

Not: İş bağlama adetleri ölçülerinde yumuşak ayak dahil değildir.

Note: It does not include binding units of measure soft feet in business.



Referans Nr.	a	b	c
2430-24350551	53	14	34
2430-24350751	73	14	39
2430-24351001	98	14	39

- Sertleştirilmiş
- Nikel Kaplama
- Hardened
- Nickel Coating

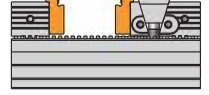
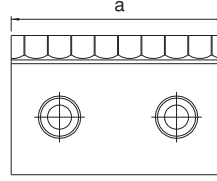
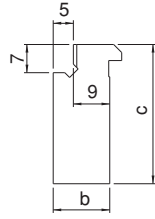

Referans Nr.	a	b	c
2430-24350552	53	14	34
2430-24350752	73	14	39
2430-24351002	98	14	39

- Sertleştirilmiş
- Nikel Kaplama
- Hardened
- Nickel Coating

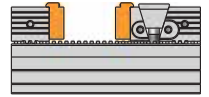
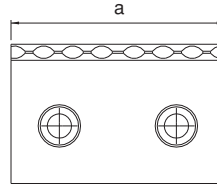
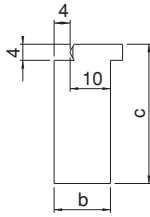

Referans Nr.	a	b	c	d
2430-24350553	53	22	34	17
2430-24350753	73	25	39	20
2430-24351003	98	25	39	20

- Sertleştirilmiş
- Nikel Kaplama
- Hardened
- Nickel Coating

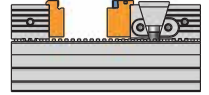
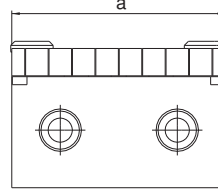
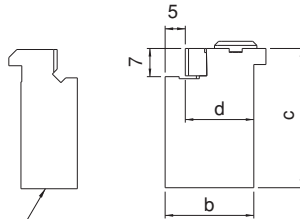

2430-24350551
2430-24350751
2430-24351001

Referans Nr.	a	b	c
2430-24350554	53	19	34
2430-24350754	73	19	39
2430-24351004	98	19	39

- Sertleştirilmiş
- Nikel Kaplama
- Hardened
- Nickel Coating

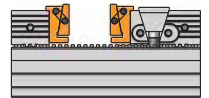
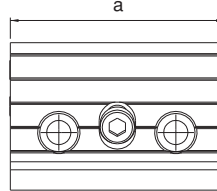
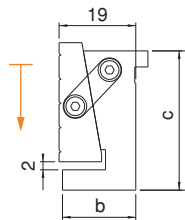

Referans Nr.	a	b	c
2430-24350555	53	14	34
2430-24350755	73	14	39
2430-24351005	98	14	39

Seri Mengene Yumuşak Çene
Serial Vice Soft Jaw

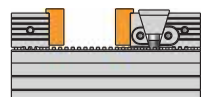
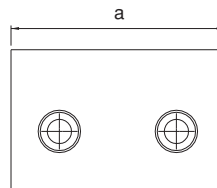
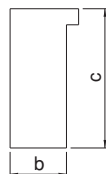

Referans Nr.	a	b	c
2430-2435055300AG	55	300	50
2430-2435055500AG	55	500	50
2430-2435075400AG	75	400	65
2430-2435075600AG	75	600	65
2430-2435100400AG	100	400	65
2430-2435100600AG	100	600	65

Seri Mengene Alt Gövde
Serial Vice Sub-Body

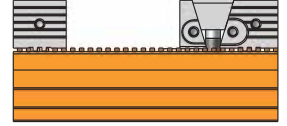
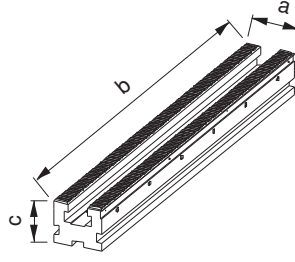

Referans Nr.	a	b	c
2430-2435055GÇ	54	65	32
2430-2435075GÇ	74	77	37
2430-2435100GÇ	99	80	37

Seri Mengene Gezer Çene
Serial Vice Portable Jaw

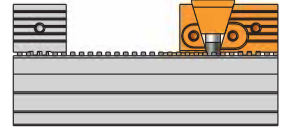
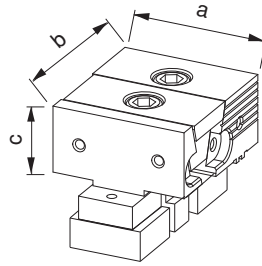

Referans Nr.	a	b	c
2430-2435055DA	54	36	32
2430-2435075DA	74	48	37
2430-2435100DA	99	48	37

Seri Mengene Dayama
Serial Vice Resting

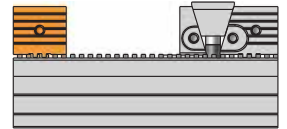
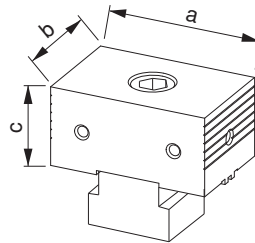

Referans Nr.	a	b	c
2430-2435055ÇA	54	36	32
2430-2435075ÇA	74	48	37
2430-2435100ÇA	99	48	37

Seri Mengene Çift Açılır
Serial Vice Double Opening

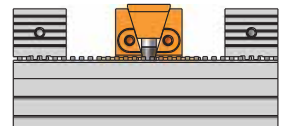
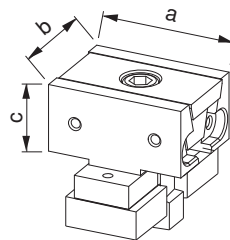

SERİ MENGENE

SERIAL VICE

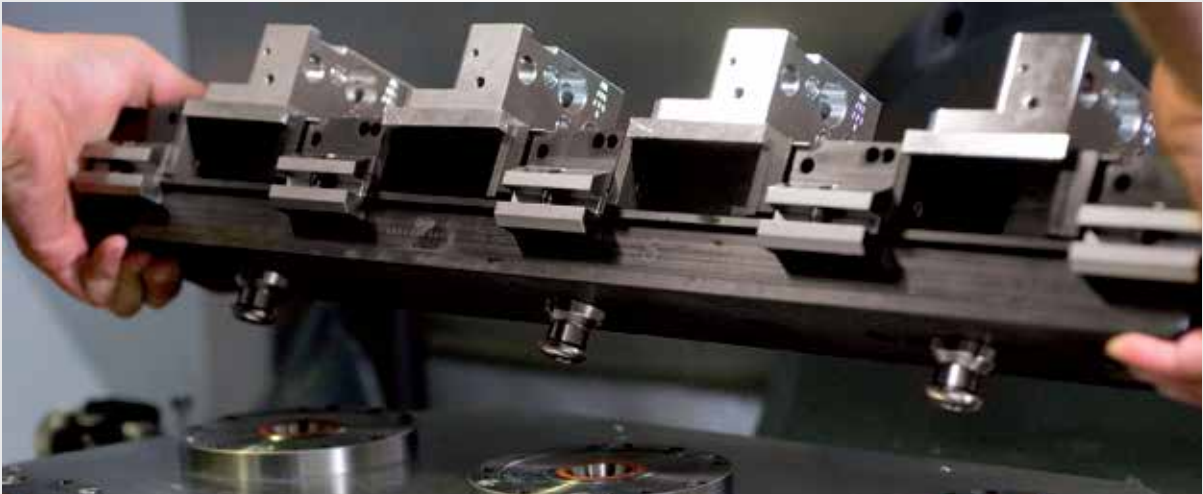
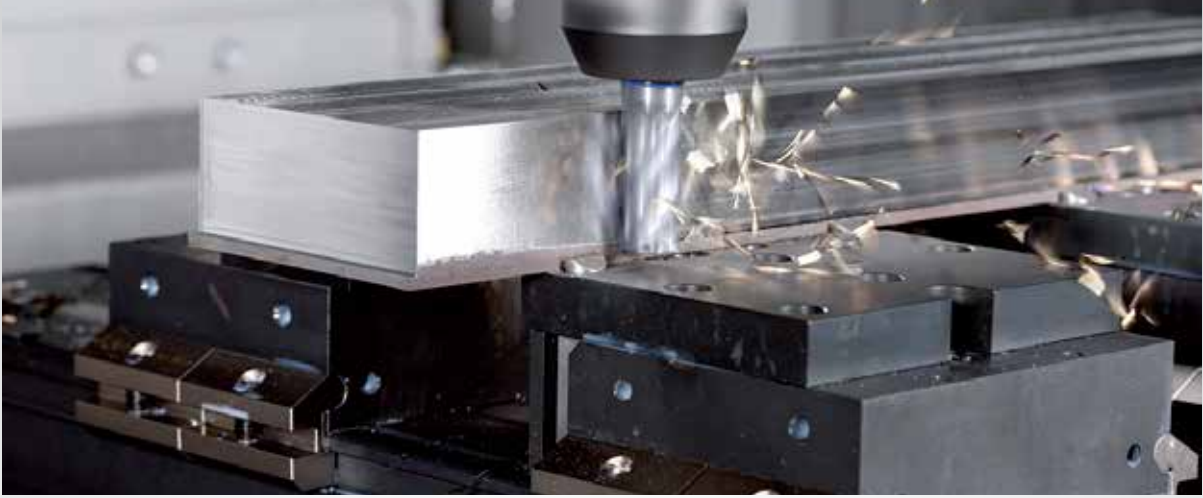

Referans Nr.	a	b	c	d
2440-SL080400	35	400	80	0-289
2440-SL080500	35	500	80	0-389
2440-SL080600	35	600	80	0-489

Ürün Nr. 2440 Seri Mengene
Product Nr. 2440 Serial Vice

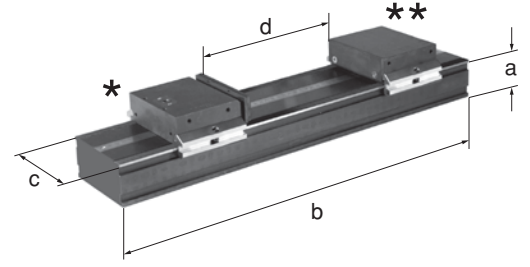

Gezer Çene Çeşitleri / Portable Jaw Types



Dayama Çeşitleri / Stopper Types



Seri Mengene

Referans Nr.	a	b	c	d
2440-SL120300	60	300	120	0-90
2440-SL120600	60	600	120	0-390
2440-SL120800	60	800	120	0-590

Ürün Nr. 2440 Seri Mengene
Product Nr. 2440 Serial Vice

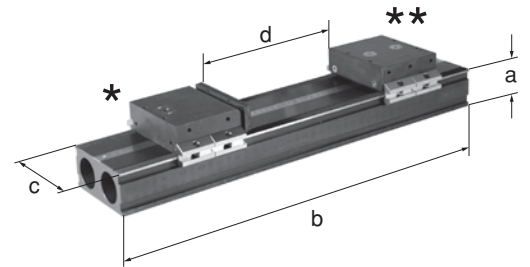

Gezer Çene Çeşitleri



Dayama

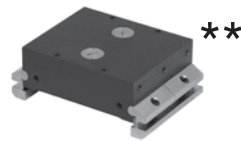

Seri Mengene Dayaması

Referans Nr.
2440-SL80120

Ürün Nr. 2440 Seri Mengene Dayaması
Product Nr. 2440 Serial Vice Workpiece Stop



Referans Nr.	L	n	n1	h	h1	h2	o	e	f	a	b	c	k	ı	p H7	Standart bağlama adedi Coupling Piece	Stroke	Sıkma Kuvveti Clamping Force Kgf
2443-055300	300	125	55	148	105	43	12.5	38	81.5	100	50	100	100	200	18	1	8	750
2443-055500	500	125	55	148	105	43	12.5	38	81.5	100	100	150	200	300	18	2	8	750
2443-075400	400	175	75	158	115	43	12.5	48	88	150	50	100	200	300	18	2	8	1100
2443-075600	600	175	75	158	115	43	12.5	48	88	150	100	150	300	400	18	2	8	1100
2443-100400	400	175	100	158	115	43	12.5	48	88	150	50	100	200	300	18	2	8	1100
2443-100600	600	175	100	158	115	43	12.5	48	88	150	100	150	300	400	18	2	8	1100

Ürün Nr. 2443 Hidrolik Çok Çeneli Seri Mengene

- Satın almadan önce bağlama adetlerini belirtiniz
- Çeneleri ayrı olarak satın almanız gerekir.

Product Nr. 2443 Hydraulic Multi Jawed Wrench Tooling

- Please, you specify about number of clamping before you make purchase.
- You need to purchase jaws separate.

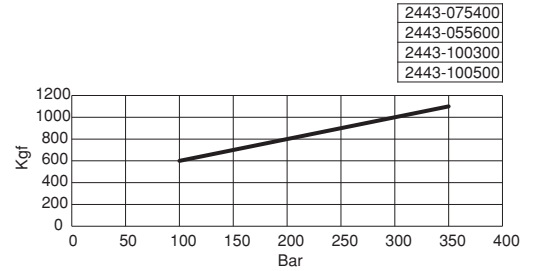
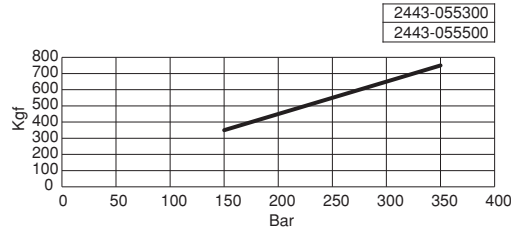
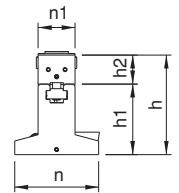
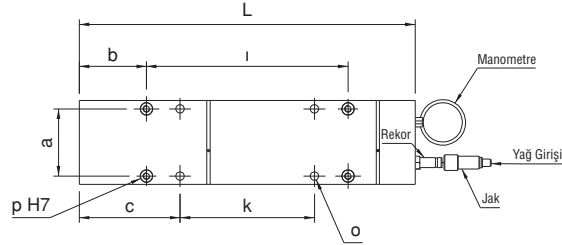
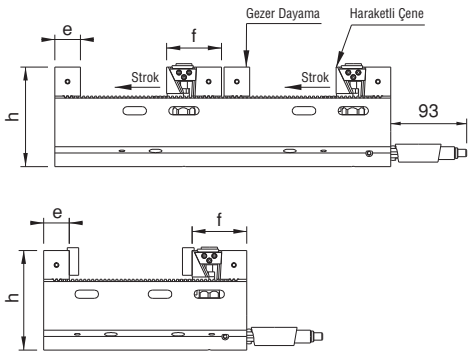
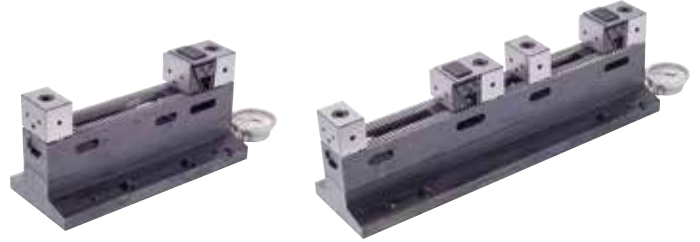

Referans Nr.	GEZER ÇENE İLE İŞ PARÇASI BAĞLAMA ADETLERİ / Numbers of Portable Jaw with Workpiece Couplings		
	1 İş parçası 1 Workpiece	2 İş parçası 2 Workpiece	3 İş parçası 3 Workpiece
2443-055300	182 mm	-	-
2443-055500	-	128 mm	-
2443-075400	-	68 mm	-
2443-075600	-	170 mm	68 mm
2443-100400	-	68 mm	-
2443-100600	-	170 mm	68 mm

Not: İş bağlama adetleri ölçülerinde yumuşak ayak dahil değildir.

Note: It does not include binding units of measure soft feet in business.



Referans Nr.	L	n	n1	h	h1	h2	o	e	f	a	b	c	k	i	p H7	Standart Bağlama Adedi Coupling Piece	Stroke	Sıkma Kuvveti Clamping Force Kgf
2445-055300	300	125	55	148	105	43	12.5	38	51.5	100	50	100	100	200	18	2	8x2	750
2445-055500	500	125	55	148	105	43	12.5	38	51.5	100	100	150	200	400	18	4	8x2	750
2445-075400	400	175	75	158	115	43	12.5	48	51.5	150	50	100	200	300	18	2	8x2	1100
2445-075600	600	175	75	158	115	43	12.5	48	51.5	150	100	150	300	500	18	4	8x2	1100
2445-100400	400	175	100	158	115	43	12.5	48	51.5	150	50	100	200	300	18	2	8x2	1100
2445-100600	600	175	100	158	115	43	12.5	48	51.5	150	100	150	300	500	18	4	8x2	1100

Ürün Nr. 2445 Hidrolik Çok Çeneli Seri Mengene

• Çeneleri ayrı olarak satın almanız gerekir.

Product Nr. 2445 Hydraulic Multi Jawed Wrench Tooling

• You need to purchase jaws separate.

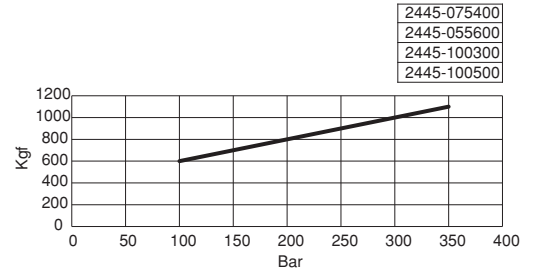
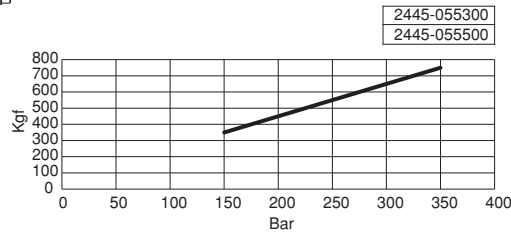
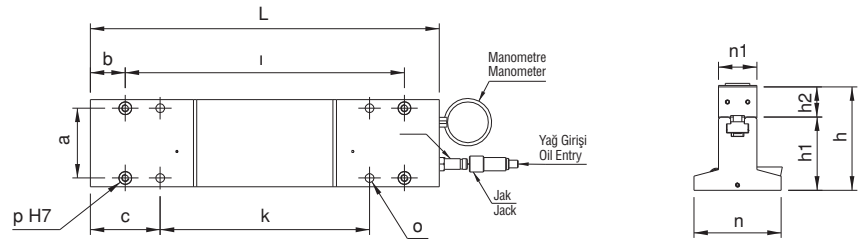
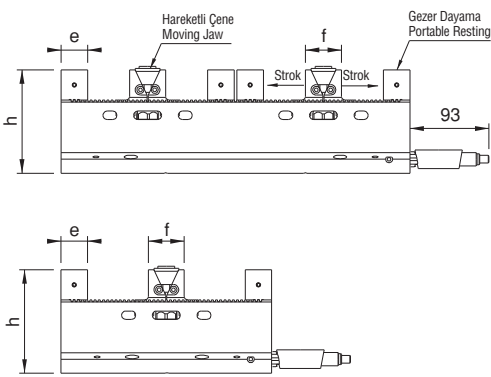

Referans Nr.	ÇİFT AÇILIR ÇENE İLE İŞ PARÇASI BAĞLAMA ADETLERİ Numbers of Double Opening Jaw with Workpiece Couplings	
	2 İş parçası 2 Workpiece	4 İş parçası 4 Workpiece
2445-055300	87 mm	-
2445-055500	-	60 mm
2445-075400	125 mm	-
2445-075600	-	75 mm
2445-100400	125 mm	-
2445-100600	-	75 mm

Not: İş bağlama adetleri ölçülerinde yumuşak ayak dahil değildir.

Note: It does not include binding units of measure soft feet in business.



Referans Nr.	a	b	c
2443-24450551	55	14	38
2443-24450751	75	14	38
2443-24451001	100	14	38

- Sertleştirilmiş
- Hardened
- Nikel Kaplama
- Nickel Coating

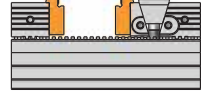
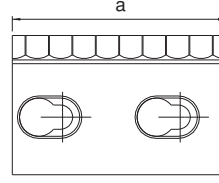
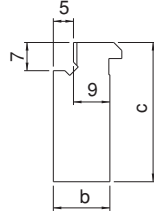

Referans Nr.	a	b	c
2443-24450552	55	14	38
2443-24450752	75	14	38
2443-24451002	100	14	38

- Sertleştirilmiş
- Hardened
- Nikel Kaplama
- Nickel Coating

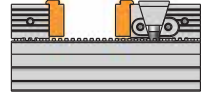
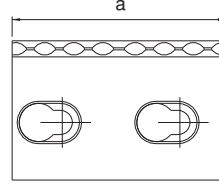
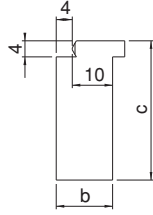

Referans Nr.	a	b	c	d
2443-24450553	55	22	38	17
2443-24450753	75	25	38	20
2443-24451003	100	25	38	20

- Sertleştirilmiş
- Hardened
- Nikel Kaplama
- Nickel Coating

2443-24450551
2443-24450751
2443-24451001

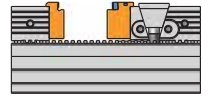
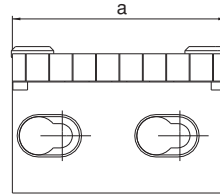
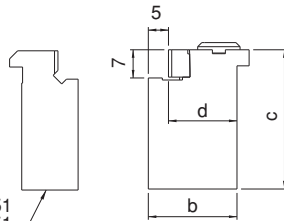

Referans Nr.	a	b	c
2443-24450554	55	19	38
2443-24450754	75	19	38
2443-24451004	100	19	38

- Sertleştirilmiş
- Hardened
- Nikel Kaplama
- Nickel Coating

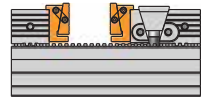
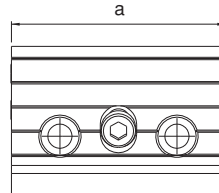
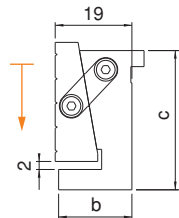

Referans Nr.	a	b	c
2443-24450555	55	14	38
2443-24450755	75	14	38
2443-24451005	100	14	38

Yumuşak Çene Soft Jaw

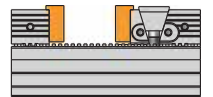
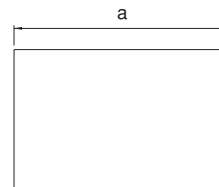
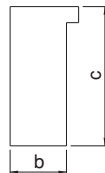

Referans Nr.	a	b	c
2443-24450556	55	14	38
2443-24450756	75	14	38
2443-24451006	100	14	38

Yumuşak Çene Soft Jaw

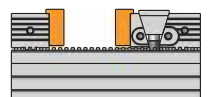
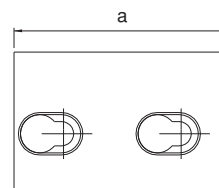
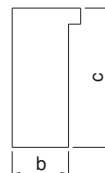

Referans Nr.	a	b	c	e
2443-055300AG	55	300	105	125
2443-055500AG	55	500	105	125
2443-075400AG	75	400	115	175
2443-075600AG	75	600	115	175
2443-100400AG	100	400	115	175
2443-100600AG	100	600	115	175

Hidrolik Alt Gövde Hydraulic Sub-body

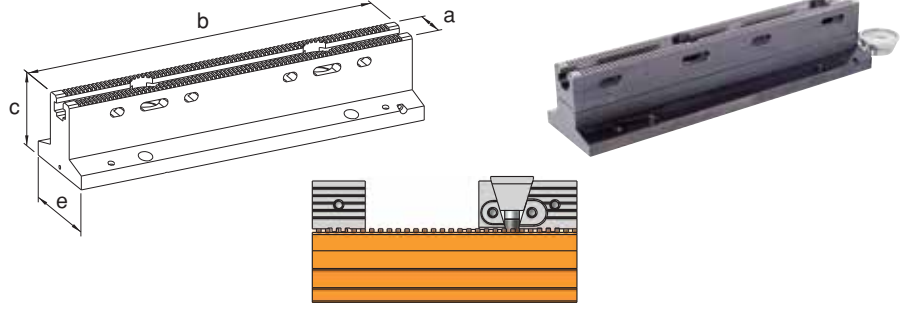

Referans Nr.	a	b	c
2443-055HÇ	55	81.5	43
2443-075HÇ	75	88	43
2443-100HÇ	100	88	43

Hareketli Çene Moving Jaw

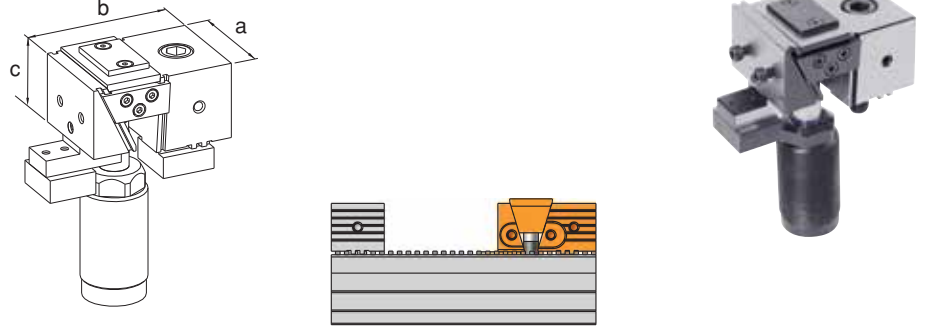

Referans Nr.	a	b	c
2443-055MHÇ	55	81.5	43
2443-075MHÇ	75	88	43
2443-100MHÇ	100	88	43

Manyetik Hareketli Çene Moving Jaw

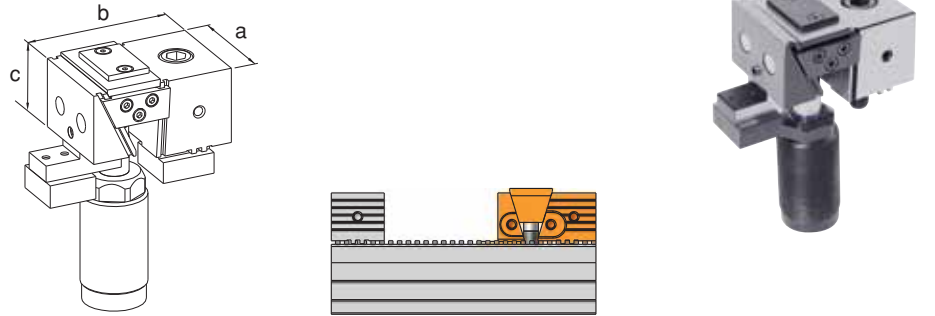

Referans Nr.	a	b	c
2443-2445055GD	55	38	43
2443-2445075GD	75	48	43
2443-2445100GD	100	48	43

Gezer Dayama Portable Resting

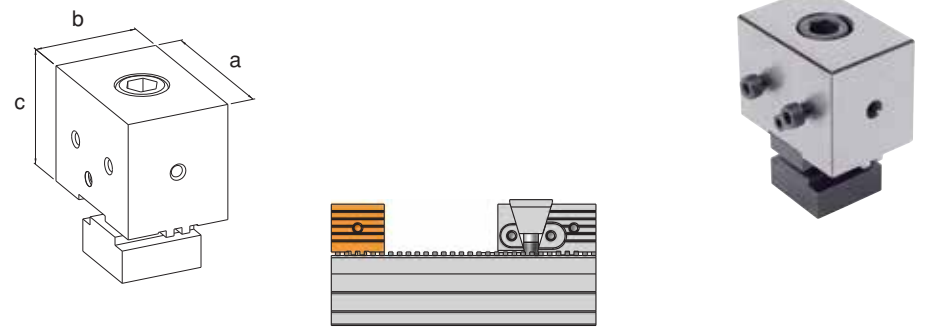

Referans Nr.	a	b	c
2443-2445055MGD	55	38	43
2443-2445075MGD	75	48	43
2443-2445100MGD	100	48	43

Manyetik Gezer Dayama Magnetic Portable Resting

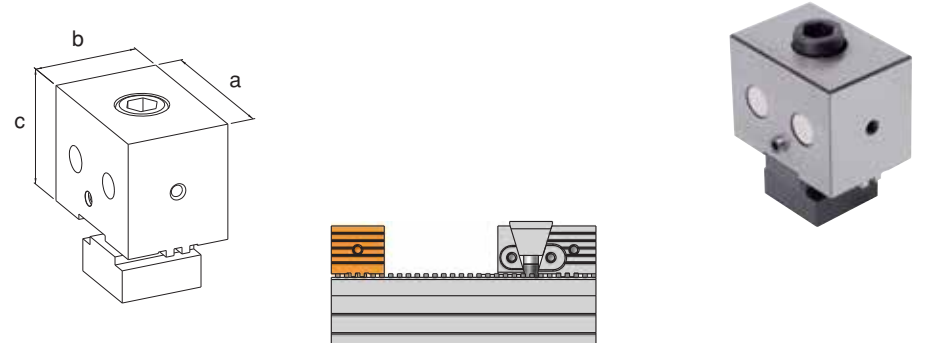

Referans Nr.	a	b	c	e
2445-055300AG	55	300	105	125
2445-055500AG	55	500	105	125
2445-075400AG	75	400	115	175
2445-075600AG	75	600	115	175
2445-100400AG	100	400	115	175
2445-100600AG	100	600	115	175

Hidrolik Alt Gövde
Hydraulic Sub-body

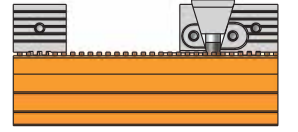
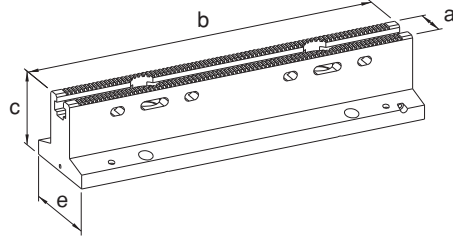

Referans Nr.	a	b	c
2445-055HÇ	55	51.5	43
2445-075HÇ	75	51.5	43
2445-100HÇ	100	51.5	43

Hareketli Çene
Moving Jaw

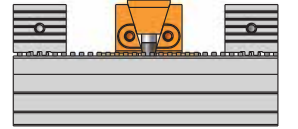
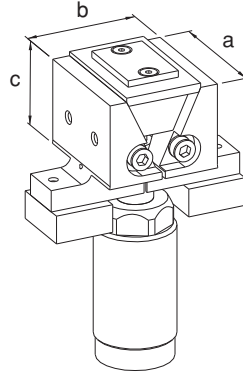

Referans Nr.	a	b	c
2445-055MHÇ	55	51.5	43
2445-075MHÇ	75	51.5	43
2445-100MHÇ	100	51.5	43

Manyetik Hareketli Çene
Moving Jaw

