

DLS

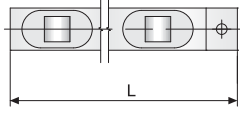

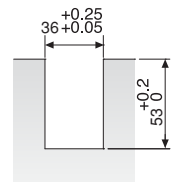
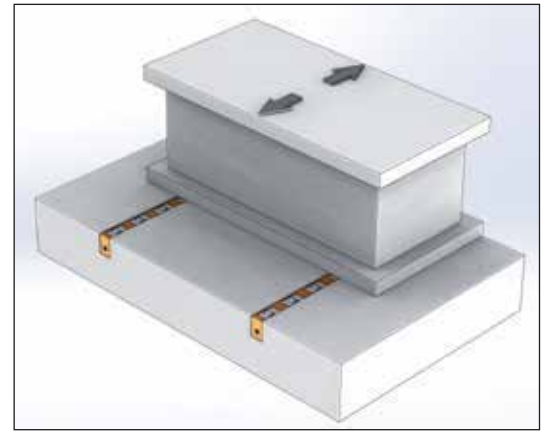

DBS

Dış Ölçüler Outline Dimensions	D□36 Serisi / Serial
	
Pleyt için işlem ölçüsü (U-Kanal) Processing Size for Plate (U-slot)	



Model DLS Hareket Yönü
Model DLS Movement Direction

Referans Nr.	L	D□36					
		DLS36			DBS36		
		Rulo Roller (DLS)		Kapasite Capacity kg	Misket Ball (DBS)		Kapasite Capacity kg
1022-0200	200	3	3	600	5	5	500
1022-0300	300	5	5	1000	7	7	700
1022-0400	400	6	6	1200	10	10	1000
1022-0500	500	8	8	1600	12	12	1200
1022-0600	600	9	9	1800	15	15	1500
1022-0700	700	11	11	2200	17	17	1700
1022-0800	800	12	12	2400	20	20	2000
1022-0900	900	14	14	2800	22	22	2200
1022-1000	1000	15	15	3000	25	25	2500
1022-1100	1100	16	16	3200	27	27	2700
1022-1200	1200	17	17	3400	30	30	3000
1022-1300	1300	18	18	3600	32	32	3200
1022-1400	1400	19	19	3800	35	35	3500
1022-1500	1500	20	20	4000	37	37	3700
1022-1600	1600	22	22	4400	40	40	4000
1022-1700	1700	24	24	4800	42	42	4200
1022-1800	1800	25	25	5000	45	45	4500
1022-1900	1900	27	27	5400	47	47	4700

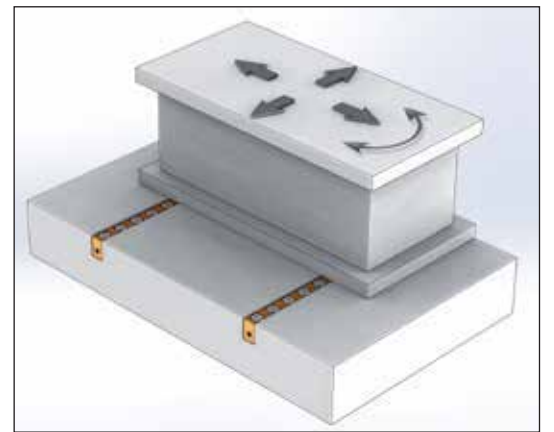

Model DBS Hareket Yönü
Model DBS Movement Direction

Ürün Nr. 1022 Hidrolik Kalıp Kaldırma Model DLS-DBS

- Standart Sıcaklık : 60°
- Opsiyonel Sıcaklık : 160°

Product Nr. 1022 Die Lifter Hydraulic Model DLS-DBS

- Standard Temperature : 60°
- Optional Temperature : 160°