

DLS

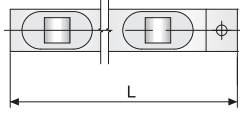

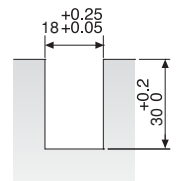
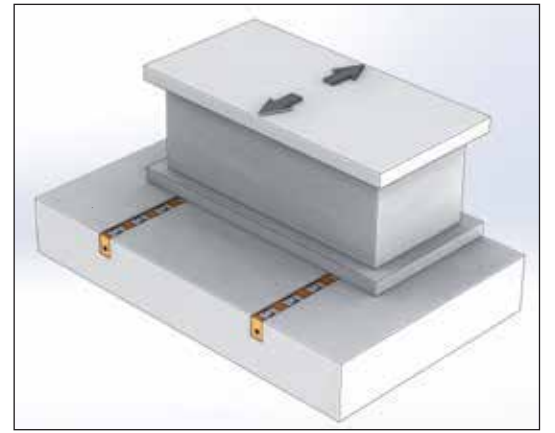

DBS

Dış Ölçüler Outline Dimensions	D□18 Serisi / Serial 
Pleyt için işlem ölçüsü (U-Kanal) Processing Size for Plate (U-slot)	



Model DLS Hareket Yönü
Model DLS Movement Direction

Referans Nr.	L	D□18					
		DLS18			DBS18		
		Rulo Roller (DLS)		Kapasite Capacity kg	Misket Ball (DBS)		Kapasite Capacity kg
1022-0200	200	3	4	200	5	6	150
1022-0300	300	5	6	300	7	8	200
1022-0400	400	6	7	350	10	11	275
1022-0500	500	8	9	450	12	13	325
1022-0600	600	9	10	500	15	16	400
1022-0700	700	11	12	600	17	18	450
1022-0800	800	12	13	650	20	21	525
1022-0900	900	14	15	750	22	23	575
1022-1000	1000	15	16	800	25	26	650

Ürün Nr. 1022 Hidrolik Kalıp Kaldırma Model DLS-DBS

- Standart Sıcaklık : 60°
- Opsiyonel Sıcaklık : 160°

Product Nr. 1022 Die Lifter Hydraulic Model DLS-DBS

- Standard Temperature : 60°
- Optional Temperature : 160°

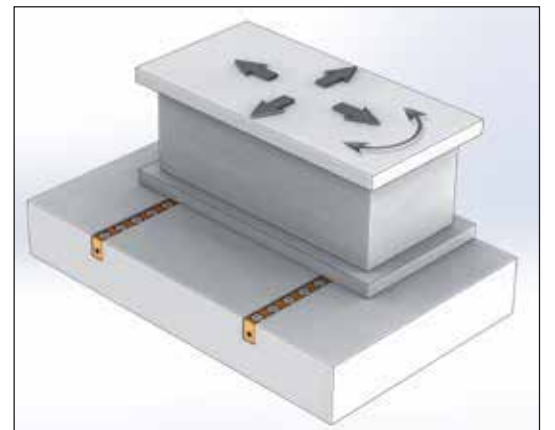

Model DBS Hareket Yönü
Model DBS Movement Direction