



KALIP ve İŞ PARÇASI BAĞLAMA SİSTEMLERİ  
*Mold and Workpiece Clamping Systems*

## YANDAN BAĞLAMA EKİPMANLARI VE SETLER

SIDE CLAMP EQUIPMENTS AND SETS



[www.er-el.com.tr](http://www.er-el.com.tr)





## DEĞERLİ MÜŞTERİMİZ;

ER-EL MAKİNA YEDEK PARÇA İMALATI SAN. VE TİC. LTD ŞTİ. olarak 1989 'dan beri kalıp bağlama ve işleme ekipmanlarında bizi güven ve kalitenin simgesi haline getiren ürünler üretmekteyiz. Geçen yıllar içinde mevcut kapasite ve toplam istihdam alanında sürekli artan bir çizgiyle her geçen gün daha sağlam ve emin adımlarla ilerleyen ER-EL; bugün başta Avrupa ülkeleri olmak üzere 45'i aşkın ülkeye ihracat yapmaktadır.

Her biri ayrı değer ve öneme sahip olan müşterilerimizin ihtiyaç ve taleplerine uygun çözümler sunmak amacıyla faaliyet gösteren ARGE bölümümüz ürün çeşitliliğini arttırmaya yönelik çalışmalarını büyük bir özveriyle sürdürmektedir. Katma değerli, kaliteli ve güvenli ürünler üretmek adına yatırımlarını arttırarak verimli, sürdürülebilir bir yol izleyen firmamız; 2004 yılında ISO 9001:2015 Kalite Yönetim Sistemini kurarak var olan kalitesini belgelendirmiştir. Akabinde ISO14001:2015 Çevre Yönetim Sistemi, ISO 45001:2018 İş Sağlığı ve Güvenliği Yönetim Sistemi ve CE sertifikalarına sahip olarak buna uygun üretim yapmaktadır.

Bugün itibari ile Kalıp & İş parçası Bağlama Ekipmanları, İşleme Sistemlerinde 4500'ü aşan hemen teslim stok ürünü çeşitleriyle konusunda lider ve üretici firma olmanın gururunu yaşamaktayız.

Standart üretimlerimiz dışında proje bazlı fişktür imalatımız da mevcuttur. Başta Savunma & Havaçılık Sanayi olmak üzere, Otomotiv, Beyaz Eşya, Ağır Makine ve Silah Sanayi sektörleri gibi Sanayinin güzide firmalarında; iş parçasına özel tasarım yapıp ürettiğimiz mekanik, pnömatik ve hidrolik fişktür ürünleri kullanılmaktadır. Sistem verimini optimize eden ürün grubumuzla; dünyaca kabul görmüş, alanında geçerliliğe sahip standartlarda üretmeye devam etmekteyiz.

Firmamız 2017 yılında taşındığı yeni fabrikasında; üretim tesisi ve yönetim binası alanında dinamik ve uzman kadrosu ile gerek standart, gerek proje bazlı fişktür çözümleri ile müşteri memnuniyeti için üstün performans ile çalışmaktadır.

Uzun yıllardır ülkemizde ve Yurtdışında kalıp bağlama elemanları üreticisi olarak sektöre hizmet veren MİKSAN Hızlı Bağlama Sistemleri firması satın alınarak ER-EL Kalıp Bağlama ve İşleme Sistemleri firmamız bünyesine katılmıştır. Bir ER-EL markası olan MİKSAN ürünleri; firmamız kalite ve güvencesiyle hizmet vermeye devam edecektir.

Siz değerli müşterilerimize ER-EL'e olan güveninizden dolayı teşekkür eder, aynı istikrar ve güvenle uzun yıllar çalışmayı temenni ederiz.

Saygılarımızla;  
ER-EL Yönetimi

## OUR ESTEEMED CUSTOMER;

*ER-EL MACHINE SPARE PARTS MANUFACTURING INDUSTRY CO.LTD. Since 1989, we have been producing products that make us a symbol of trust and quality in mold clamping and processing equipment. Over the years, ER-EL has progressed more and more confidently with its increasing capacity and total employment. Today, it export to more than 45 countries, mainly European countries.*

*Our R & D department, which operates to provide solutions that meet the needs and demands of our customers, each of which has a distinct value and importance, continues its efforts to increase the product variety with great devotion. Our company follows an efficient, sustainable way by increasing its investments in order to produce value added, quality and safe products; In 2004, it established ISO 9001:2015 Quality Management System and documented its existing quality. The company has ISO14001:2015 Environmental Management System, ISO 45001:2018 Occupational Health and Safety Management System.*

*As of today, we are proud to be the leader and manufacturer company in the field of mold & workpiece clamping equipment and processing systems, over 4500 fast immediate delivery stock products.*

*In addition to our standard production, we also produce project-based special fixture apparatus. Especially in Defense & Aviation Industry, Automotive, White Goods, Heavy Machinery and Weapon Industry sectors such as industry-renowned companies; mechanical, pneumatic and hydraulic fixture products that we design and produce for the workpiece are used. With our product group optimizing system efficiency; we continue to produce world-accepted standards that are valid in the field.*

*Our company moved to the new factory in 2017; with its dynamic and expert staff in the field of production facility and management building, it works with superior performance for customer satisfaction with both standard and project based fixture solutions.*

*MIKSAN Fast Coupling Systems company which has been serving to the sector as a manufacturer of mold fasteners in our country and abroad for many years has been purchased as of and ER-EL Mold Clamping and Processing Systems has joined our company. MIKSAN products which are an ER-EL brand; Our company will continue to serve with quality and assurance.*

*We would like to thank you, our esteemed customers for your trust in ER-EL and hope to work for many years with the same stability and confidence.*





Kind regards;  
ER-EL Directors

# index

Nr. 1990 S. 05 	Nr. 2010 S. 06 	Nr. 2020 S. 07 	Nr. 2020 S. 07 	Nr. 2020 S. 07 	Nr. 2020 S. 07 
Nr. 2020 S. 07 	Nr. 2030 S. 09 	Nr. 2050 S. 10 	Nr. 2070 S. 11 	Nr. 2070 S. 12 	Nr. 2070 S. 13 
Nr. 2072 S. 14 	Nr. 2073 S. 14 	Nr. 2077 S. 15 	Nr. 2080 S. 15 	Nr. 2090 S. 16 	Nr. 2095 S. 17 
Nr. 2095 S. 17 	Nr. 2098 S. 18 	Nr. 2098 S. 18 	Nr. 2105 S. 19 	Nr. 2105 S. 19 	Nr. 2105 S. 20 
Nr. 2105 S. 20 	Nr. 2105 S. 21 	Nr. 2105 S. 21 	Nr. 2110 S. 22 	Nr. 2120 S. 22 	Nr. 2130 S. 22 
Nr. 2135 S. 23 	Nr. 2137 S. 23 	Nr. 2139 S. 24 	Nr. 2141 S. 25 	Nr. 2143 S. 25 	Nr. 2144 S. 26 
Nr. 2150 S. 27 	Nr. 2170 S. 27 	Nr. 2190 S. 28 	Nr. 2210 S. 28 	Nr. 2230 S. 29 	Nr. 2250 S. 29 
Nr. 2270 S. 30 	Nr. 2290 S. 30 	Nr. 2385 S. 32 	Nr. 2390 S. 33 		

# SETLER SETS



Referans Nr.			 (kg)	d x L	DIN 6379
1990-1012	M10x12	265x255	6.44	M10x80-100-160-200	
1990-1214	M12x14	305x255	8.72	M12x80-100-160-200	
1990-1416	M14x16	435-255	12.98	M14x80-100-160-200	
1990-1618	M16x18	435-255	16.30	M16x80-100-160-200	
1990-1820	M18x20	495x255	17.82	M18x80-100-160-200	
1990-2022	M20x22	540x255	23.10	M20x100-125-160-200	

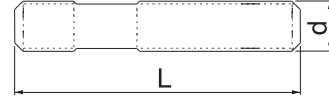

#### Ürün Nr. 1990 Vidalı Yükselticili Bağlama Set





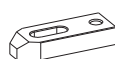

- Tabla üzerine iş parçası ve aparatların hızlı ve güvenli bir şekilde bağlanması için çelik mamülden üretilmiş parçalardan oluşan bağlama seti

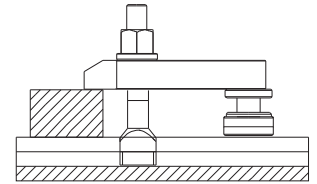
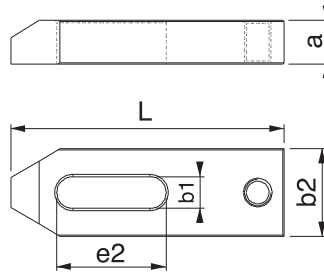
#### Product Nr. 1990 Screwed Coupling Set with Lifter

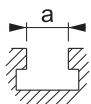
- This is the coupling set produced from steel product in order to couple the work piece or apparatuses on the table in a rapid and safe way.

Nr.	L	b1		a	e2	b2
1330	80	11	M10	15	30	30
1330	100	14.5	M12-M14	20	40	40
1330	125					
1330	125	18.5	M16-M18	25	45	50
1330	160					
1330	160	22.5	M20-M22	30	60	60
1330	200					



					
	DIN 508	DIN 6330 B	Nr 1830	DIN 6331	DIN 6340
12	M10	M10	M10	M10	M10
14	M12	M12	M12	M12	M12
16	M14	M14	M14	M14	M14
18	M16	M16	M16	M16	M16
20	M18	M18	M18	M18	M18
22	M20	M20	M20	M20	M20

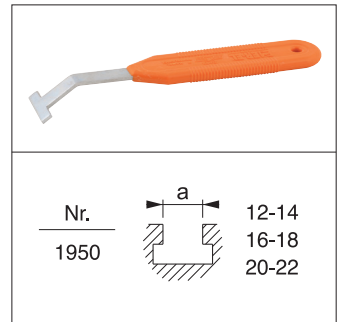

Nr.	h	H	d	D
1510	23	30	M16	34
1510	40	60	M16	34
1510	70	100	Tr 30x4	50
1510	100	140	Tr 30x4	50

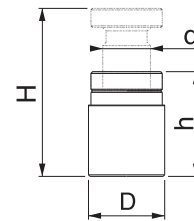





#### Ürün: 52 Parça Vida Yükselticili İş Bağlama Set

- 6 adet DIN 508 T-Pabuç (M20x22'de 4 adet)
- 16 adet DIN 6379 saplama
- 6 adet DIN 6330B takviyeli somun
- 4 adet DIN 6331 pullu somun
- 2 adet Nr. 1830 uzatma somun
- 4 adet DIN 6340 kalın pul
- 4 adet Nr. 1330 destek delikli pabuç
- 8 adet Nr. 1510 vida diş yükseltici destek
- 1 adet Nr. 1950 T-Kanal temizleyici
- 1 adet statik boyalı çelik set
- Not: M20 VBS'de somun ve pul 4'er adet
- M10-12 VBS'de 1510 yükseltici 6 adet konulmaktadır.

#### Product: 52 piece set of Screwed Coupling Set with Lifter

- 6 pieces of DIN 508 T-Nut (M20x22 4 piece)
- 16 pieces of DIN 6379 Stud
- 6 pieces of DIN 6330B Supported Nut
- 4 pieces of DIN 6331 Nut with Washer
- 2 pieces of No. 1830 Extension Nut
- 4 pieces of DIN 6340 Thick Washer
- 4 pieces of No. 1330 Clamp with Support Hole
- 8 pieces of No. 1510 Screw Thread Lifter Support
- 1 piece of No. 1950 T-Slot Scraper
- 1 piece of Steel Set with Statical Paint
- Note: 1990-2022= Hexagon nut and washer = 4 pcs
- 1990-1012 and 1990-1214= 1510 support 6 pcs

Referans Nr.				DIN 6379 d x L 
2010-1012	M10x12	330x255	7.27	M10x80-100-160-200
2010-1214	M12x14	380x255	9.26	M12x80-100-160-200
2010-1416	M14x16	435x255	12.29	M14x80-100-160-200
2010-1618	M16x18	435x255	15.62	M16x80-100-160-200
2010-1820	M18x20	495x255	18.00	M18x80-100-160-200



### Ürün Nr. 2010 Merdiven Yükselticili Bağlama Set



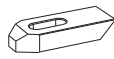

- Tabla üzerine iş parçası ve aparatların hızlı ve güvenli bir şekilde bağlanması için çelik mamülden üretilmiş parçalardan oluşan bağlama seti.

### Product Nr. 2010 Coupling Set with Serrated Hell Block

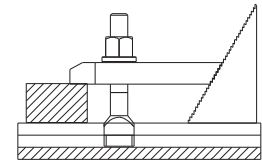
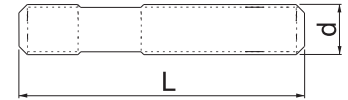
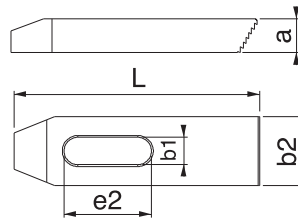
- This is the coupling set produced from steel product in order to couple the work piece or apparatuses on the table in a rapid and safe way.

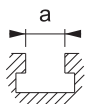
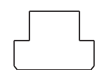
Nr.	L	b1		a	e2	b2
1290	80 100	11	M10	15	30 45	30
1290	100 125	14.5	M12-M14	20	45 55	40
1290	125 160	18.5	M16-M18	25	65 65	50

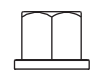

					
a	DIN 508	DIN 6330 B	Nr 1830	DIN 6331	DIN 6340
12	M10	M10	M10	M10	M10
14	M12	M12	M12	M12	M12
16	M14	M14	M14	M14	M14
18	M16	M16	M16	M16	M16
20	M18	M18	M18	M18	M18

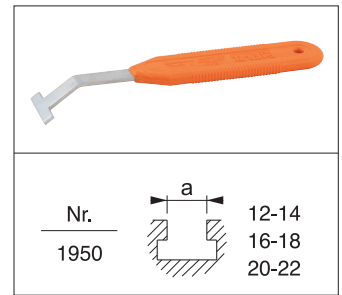

Nr.		
1950	a	12-14 16-18 20-22

Nr.	h-H	a	min-max
1310	37-85	57	0-40
1310	48-112	73	0-60
1310	58-139	90	0-75
1310	66-165	108	0-90

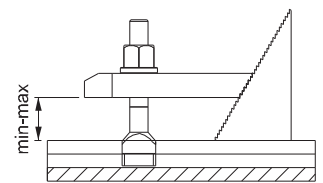
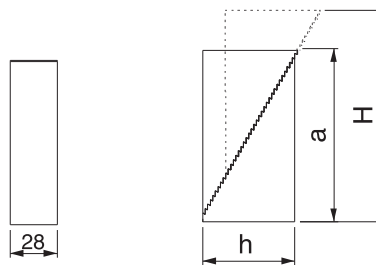

### Ürün: 52 Parça Merdiven Destekli İş Bağlama Set

- 6 adet DIN 508 T-Pabuç
- 16 adet DIN 6379 saplama
- 6 adet DIN 6330B takviyeli somun
- 4 adet DIN 6331 pullu somun
- 2 adet 1830 uzatma somun
- 4 adet DIN 6340 kalın pul
- 4 adet Nr.1290 merdiven pabuç
- 8 adet Nr. 1310 merdiven dış destek
- 1 adet Nr. 1950 T-Kanal temizleyici
- 1 adet statik boyalı çelik set

### Product: 52 piece set of Coupling Set with Serrated Hell Block

- 6 pieces of DIN 508 T-Nut (M20x22 4 piece)
- 16 pieces of DIN 6379 Stud
- 6 pieces of DIN 6330B Supported Nut
- 4 pieces of DIN 6331 Nut with Washer
- 2 pieces of No. 1830 Extension Nut
- 4 pieces of DIN 6340 Thick Washer
- 4 pieces of No. 1290 Serrated Clamp
- 8 pieces of No. 1310 Clamp with Support Hole
- 1 piece of No. 1950 T-Slot Scraper
- 1 piece of Steel Set with Statical Paint

Referans Nr.			Tork Torque Nm	Sıkma Kuvveti Clamping Force kgf	L	m	n	
2020-120125	M12	14-16-18	45	1500	125	20	15	1414
2020-120250	M12		45	1500	250	20	15	1528
2020-120500	M12		45	1500	500	20	15	1755
2020-121000	M12		45	1500	1000	20	15	2210
2020-160125	M16	18-20-22-24	90	4000	125	33	21	3495
2020-160250	M16		90	4000	250	33	21	3810
2020-160500	M16		90	4000	500	33	21	4480
2020-161000	M16		90	4000	1000	33	21	5820

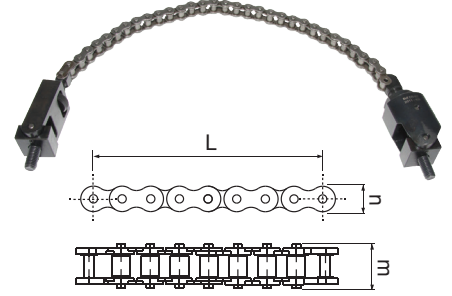

#### Ürün Nr. 2020 Zincirli Sıkma

- Silindirik ve oval iş parçalarının bağlanabilmesi için tasarlanmıştır.
- Sertleştirilmiş
- Siyah kaplama

#### Product Nr. 2020 Fixture Chain

- It is designed for clamping of cylinder and oval workpieces.
- Hardened
- Black coating

Referans Nr.		a	b	c	e1	f1	h1 min	h1 max	m	s1	Sıkma Kuvveti Clamping Force kgf	
2020-12125	14-16-18	36	36	18	49	21	96	125	M12	35	1500	580
2020-16162	18-20-22-24	37	44	25	64	29	117	162	M16	45	4000	1275

#### Ürün Nr. 2020 Ayar Ünitesi

- Sertleştirilmiş
- Siyah kaplama

#### Product Nr. 2020 Setting Unit

- Hardened
- Black coating

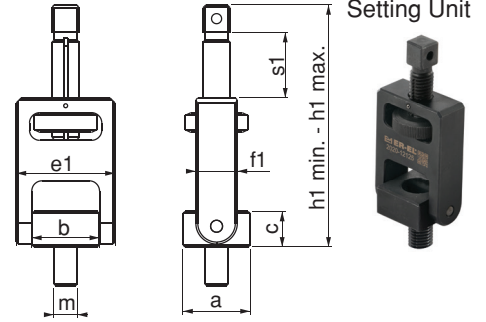

Referans Nr.		a	b	c	e2	f2	h2 min	h2 max	m	s2	sw	Tork Torque Nm	Sıkma Kuvveti Clamping Force kgf	
2020-12127	14-16-18	36	36	18	54	49	111	127	M12	16	36	45	1500	945
2020-16170	18-20-22-24	37	44	25	70	62	140	170	M16	30	46	90	4000	1890

#### Ürün Nr. 2020 Kanca Ünitesi

- Sertleştirilmiş
- Siyah kaplama

#### Product Nr. 2020 Hook Unit

- Hardened
- Black coating

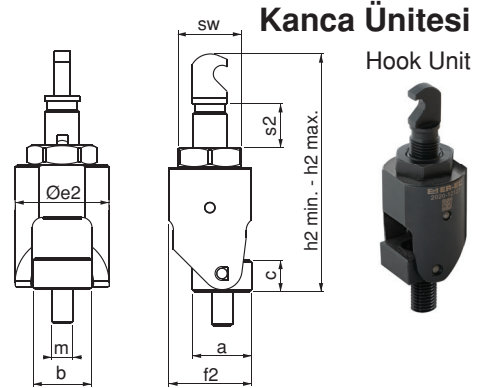
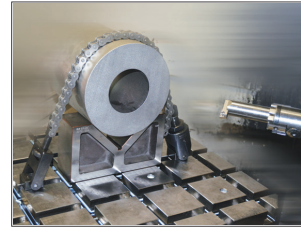

Referans Nr.	L1	L2	
2020-127	127-173	97	350
2020-164	164-225	126	800

#### Ürün Nr. 2020 Zincir Soketi

- Zincir burkulmalarını önlemek için kullanılır
- Sertleştirilmiş
- Siyah kaplama

#### Product Nr. 2020 Chain Socket

- Used to prevent chain buckling.
- Hardened
- Black coating

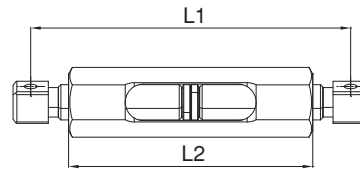

Referans Nr.	SW	SW1	
2020-36	36	1/2	320
2020-46	46	1/2	520

#### Ürün Nr. 2020 Tork Anahtarı Soketi

- Tork anahtarı için kullanılır.
- Sertleştirilmiş
- Siyah kaplama

#### Product Nr. 2020 Torque Wrench Socket

- Used to for torque wrench.
- Hardened
- Black coating

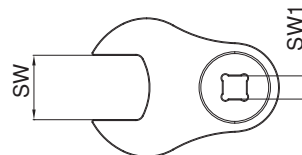

#### Tork Anahtarı Soketi

### Torque Wrench Socket





# YANDAN BAĞLAMA PABUÇLAR

*SIDE CLAMPS*





Referans Nr.		c	L	b	n	k	k1	k2	L1	d	d1	d2	sw	sıkma kuvveti clamping force Kgf	Tork Değeri Allowable Screw Torque (N-m)	
2030-14	14	5	90	23	47	47	26	26	65	M12	M12	M12	10	2000	35	3490
2030-16	16															3670
2030-18	18															5000
2030-20	20															5355
2030-22	22															5720
2030-24	24															6190
2030-28	28															6650

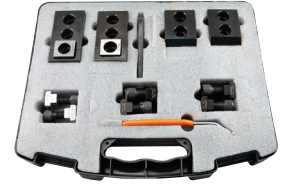





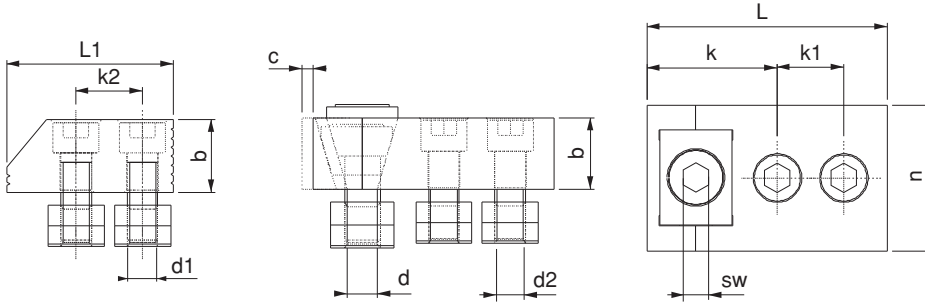

#### Ürün Nr. 2030 Dereceli Yandan Bağlama Set

- İş parçasını dayama yönünde sıkıldığında parçanın özgün yapısını değişikliğe sebep vermez
- Sertleştirilmiş
- Siyah kaplama
- Plastik kutuda set

#### Product Nr. 2030 Graded side Wrench Set

- When the product clamps the work piece in the direction of rest, it does not cause alteration in the genuine structure of the piece.
- Hardened
- Black coating
- Set is in the plastic box



Set İçindekiler / The set consists of						
Parça Part						
Adet Quantity	2	2	10	10	1	1



Referans Nr.	
2035-14	14
2035-16	16
2035-18	18
2035-20	20
2035-22	22
2035-24	24
2035-28	28

## Dereceli Yandan Bağlama Gövde

### Graded side Wrench Body





Referans Nr.	
2040-14	14
2040-16	16
2040-18	18
2040-20	20
2040-22	22
2040-24	24
2040-28	28

## Dereceli Yandan Bağlama Dayama

### Graded side Wrench Pluggable



Not: Sabit dayamanın dereceli tarafı ince parçalar, düz tarafı ise kalın parçalarda kullanılmak üzere iki farklı şekilde kullanılabilir.  
Note: Fixed rest can be used as two different ways: Graded side is used for thin pieces and the Straight side is used with thick pieces.

Referans Nr.		c	L	L1	L2	L3	b	b1 ±0.01	n	k	k1	k2	d	d1	d2	sw	sıkma kuvveti clamping force Kgf	Tork Değeri Allowable Screw Torque (N-m)	
2050-14	14	5	110	90	85	65	41	18	47	47	26	26	M12	M12	M12	6	1000	15	5920
2050-16	16																		6210
2050-18	18																		8090
2050-20	20																		8440
2050-22	22	5	115	95	85	65	46	18	57	52	26	26	M12	M12	M12	8	1250	20	8825
2050-24	24																		10080
2050-28	28																		10750







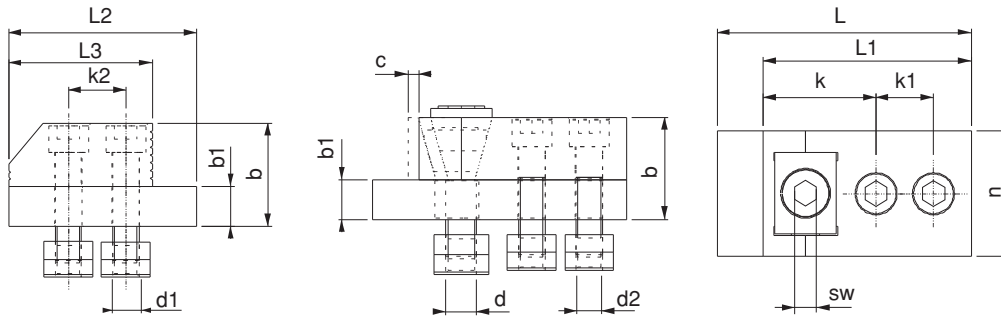

### Ürün Nr. 2050 Dereceli Yandan Bağlama (Paralelli) Set

- İş parçasını dayama yönünde sıkıldığında parçanın özgün yapısını değişikliğe sebep vermez. Paralelli oluşundan dolayı işlenen parçaya delik işlemi uygulanabilir.
- Sertleştirilmiş
- Siyah kaplama
- Plastik kutuda set

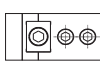
### Product Nr. 2050 Graded side Wrench Set (With Parallel)

- When the product clamps the work piece in the direction of rest, it does not cause alteration in the genuine structure of the piece. Because of being with parallel, hole process can be applied on the machined piece.
- Hardened
- Black coating
- Set is in the plastic box



Set İçindekiler / The set consists of						
Parça Part						
Adet Quantity	2	2	10	10	2	1

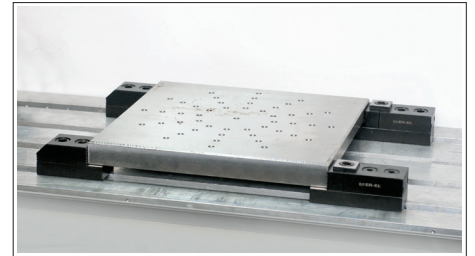

## Dereceli Yandan Bağlama (Paralelli) Gövde

Referans Nr.	
2055-14	14
2055-16	16
2055-18	18
2055-20	20
2055-22	22
2055-24	24
2055-28	28





## Dereceli Yandan Bağlama (Paralelli) Dayama

Referans Nr.	
2060-14	14
2060-16	16
2060-18	18
2060-20	20
2060-22	22
2060-24	24
2060-28	28

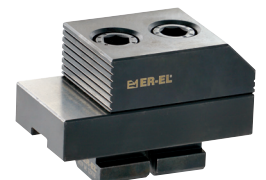
Not: Sabit dayamanın dereceli tarafı ince parçalar, düz tarafı ise kalın parçalarda kullanılmak üzere iki farklı şekilde kullanılabilir.  
Note: Fixed rest can be used as two different ways: Graded side is used for thin pieces and the Straight side is used with thick pieces.



Referans Nr.		c	L	b	b1	n	n1	n2	k	k1	k2	sw	i	h	h1	d	d1	sıkma kuvveti clamping force Kgf	Tork Değeri Allowable Screw Torque (N-m)	
2070-14	14	10	142	24	8	37	12.5	18.5	65	54	26	6	65	23	10	M12	M12	850	15	3575
2070-16	16																			3710
2070-18	18	14	145	28	10	48	12.5	18.5	74	56	26	8	65	28	11	M12	M12	1000	35	5215
2070-20	20																			5400
2070-22	22																			5610

#### Ürün Nr. 2070 Kızaklı Yandan Bağlama Set

- Hareketli çenenin kızaklı yapısından dolayı iş parçasını dayama ve pleyt yönüne sıkar. Çenenin geniş hareketi iş parçasını bağlama ve sökmede kolaylık sağlar.
- DIN 650 T-Kanala uyumludur
- Çene Sertlik : Sertleştirilmiş
- Siyah kaplama
- Plastik kutuda set

#### Product Nr. 2070 Sliding Side Wrench Set

- Because of the sliding structure of the moving jaw it clamps the work piece in the direction of resting and plate.
- Wide movement of the jaw provides convenience in coupling and dismantling of the workpiece.
- It is in compliance with DIN 650 T-Slot
- Hardness of jaw: Hardened
- Black coating
- Set is in the plastic box

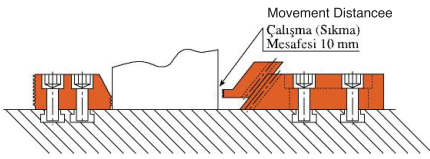
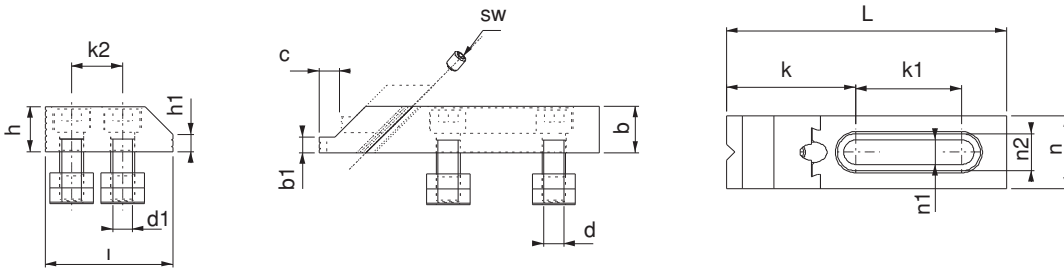





Not: Sabit dayamanın dereceli tarafı ince parçalar, düz tarafı ise kalın parçalarda kullanılmak üzere iki farklı şekilde kullanılabilir.

Note: Fixed rest can be used as two different ways: Graded side is used for thin pieces and the Straight side is used with thick pieces.

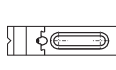
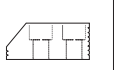

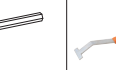
#### Set İçindekiler / The set consists of

Parça Part						
Adet Quantity	2	2	8	8	2	1

Referans Nr.	
2075-14	14
2075-16	16
2075-18	18
2075-20	20
2075-22	22
2075-24	24
2075-28	28

## Kızaklı Yandan Bağlama Gövde

### Sliding Side Wrench Body



Referans Nr.	
2040-14	14
2040-16	16
2040-18	18
2040-20	20
2040-22	22
2040-24	24
2040-28	28

## Kızaklı Yandan Bağlama Dayama

### Sliding Side Wrench Pluggable



Referans Nr.	a	Sıkma Kuvveti Clamping Force (Kgf)	Nm	(kg)
2070-MBS701214	14	2500	60	3.14
2070-MBS701216	16	2500	60	3.14
2070-MBS701218	18	2500	60	3.14
2070-MBS701220	20	2500	60	3.14

**Ürün Nr. 2070 Yandan Bağlama Set**

- Mafsallı tasarımıyla düz olmayan yüzeylerde dahi mevcut yüzey şeklini alarak emniyetli bağlama yapar.

**Product Nr. 2070 Side Wrench Set**

- With its articulated design, it makes safe bonding even on uneven surfaces by taking the existing surface shape.

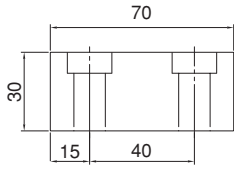

Genişlik / Width 40 mm.

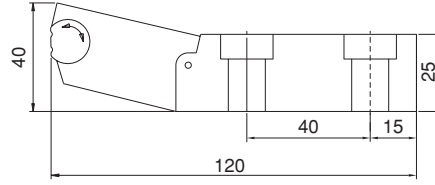

Genişlik / Width 40 mm.

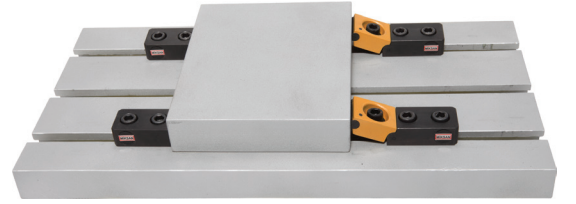
**Yandan Bağlama Gövde**

Side Press Body

Referans Nr.	a	(kg)
2070-MS701114	14	0.87
2070-MS701116	16	0.87
2070-MS701118	18	0.87
2070-MS701120	20	0.87

**Ürün Nr. 2070 Yandan Bağlama Gövde**

- Mafsallı tasarımıyla düz olmayan yüzeylerde dahi mevcut yüzey şeklini alarak emniyetli bağlama yapar.

**Product Nr. 2070 Side Press Body**



- With its articulated design, it makes safe bonding even on uneven surfaces by taking the existing surface shape.

**Yandan Bağlama Dayama**

Side Press Stopper

Referans Nr.	a	(kg)
2070-MD702114	14	0.65
2070-MD702116	16	0.65
2070-MD702118	18	0.65
2070-MD702120	20	0.65

**Ürün Nr. 2070 Yandan Bağlama Dayama****Product Nr. 2070 Side Press Stopper**

Referans Nr.		Sıkma Kuvveti Clamping Force (Kgf)	Nm	
2070-MBS801114	14	2500	60	6.15
2070-MBS801116	16	2500	60	6.15
2070-MBS801118	18	2500	60	6.15
2070-MBS801120	20	2500	60	6.15

#### Ürün Nr. 2070 Yandan Bağlama (Paralelli) Set

- Mafsallı tasarımıyla düz olmayan yüzeylerde dahi mevcut yüzey şeklini alarak emniyetli bağlama yapar.

#### Product Nr. 2070 Side Wrench Set (With Parallel)

- With its articulated design, it makes safe bonding even on uneven surfaces by taking the existing surface shape.

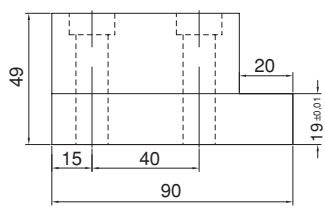

Genişlik / Width 40 mm.

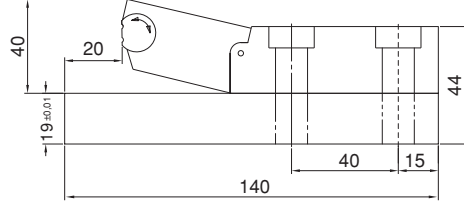



Genişlik / Width 40 mm.

## Yandan Bağlama (Paralelli) Set

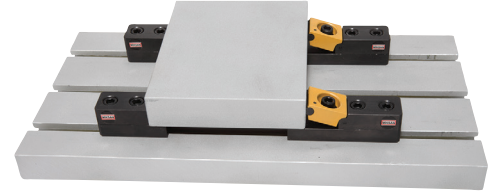
Side Wrench Set (With Parallel)



Referans Nr.		
2070-MS801214	14	1.86
2070-MS801216	16	1.86
2070-MS801218	18	1.86
2070-MS801220	20	1.86

#### Ürün Nr. 2070 Yandan Bağlama Gövde

- Mafsallı tasarımıyla düz olmayan yüzeylerde dahi mevcut yüzey şeklini alarak emniyetli bağlama yapar.



#### Product Nr. 2070 Side Press Body

- With its articulated design, it makes safe bonding even on uneven surfaces by taking the existing surface shape.

## Yandan Bağlama Gövde

Side Press Body



Referans Nr.		
2070-MD802214	14	1.18
2070-MD802216	16	1.18
2070-MD802218	18	1.18
2070-MD802220	20	1.18

#### Ürün Nr. 2070 Yandan Bağlama Dayama

#### Product Nr. 2070 Side Press Stopper

## Yandan Bağlama Dayama

Side Press Stopper



Referans Nr.	A	B	C	D	E	F	G	H	J	K	L	M	Sıkma Kuvveti Clamping Force Kgf	Tork Değeri Allowable Screw Torque (N-m)	
2072-08016	39.5	65	7.5	25	45	16	7	1.5	7	4	M8	25	400	8	160
2072-12022	60	85	10	40	60	22	12	2	9	6	M12	35	900	26	450
2072-16030	77	100	14	50	70	30	14	2	13	8	M16	40	1700	60	900

**Ürün Nr. 2072 Yandan Bağlama**  
• Siyah Kaplama

**Product Nr. 2072 Side Clamps**  
• Black Coating

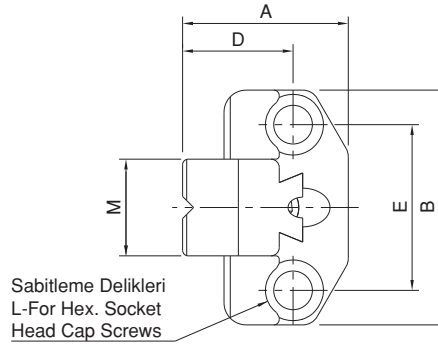
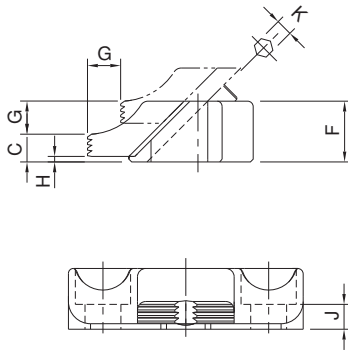

**Yandan Bağlama**

## Side Clamps

Referans Nr.	A	B	C	D	E	F	G	H	J	K	L	M	Sıkma Kuvveti Clamping Force Kgf	Tork Değeri Allowable Screw Torque (N-m)	
2073-08016	39.5	65	19.5	25	45	16	7	1.5	7	4	M8	25	400	8	180
2073-12022	60	85	29	40	60	22	12	2	9	6	M12	35	900	26	500
2073-16030	77	100	38	50	70	30	14	2	13	8	M16	40	1700	60	1010

**Ürün Nr. 2073 Yandan Bağlama**  
• Çene Sertlik: Sertleştirilmiş  
• Siyah Kaplama

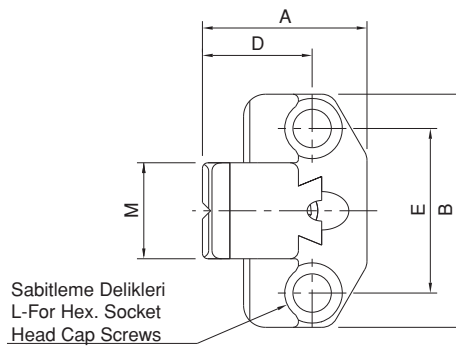
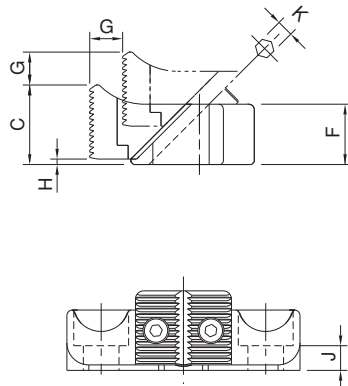
**Product Nr. 2073 Side Clamps**  
• Hardness of jaw: Hardened  
• Black Coating



Referans Nr.	A	B	C	D	E	F	G	H	J	K	L	M	N
2077-08001	44	32	20	8	28.5	4	26.5	23	7	15	19	10	M8x1.25
2077-10001	54	40	25	10	35	5	33	29	9	16	24	12	M10x1.5
2077-12001	62	46	30	12	39.5	5.5	37.5	35	11	17	27	14	M12x1.75

Referans Nr.	P	Sıkma Kuvveti Clamping Force Kgf	Tork Değeri Allowable Screw Torque (N-m)	 (g)
2077-08001	6	350	45	160
2077-10001	8	550	55	310
2077-12001	10	700	70	490



#### Ürün Nr. 2077 Yandan Bağlama

- Siyah Kaplama

#### Product Nr. 2077 Side Clamps

- Black Coating

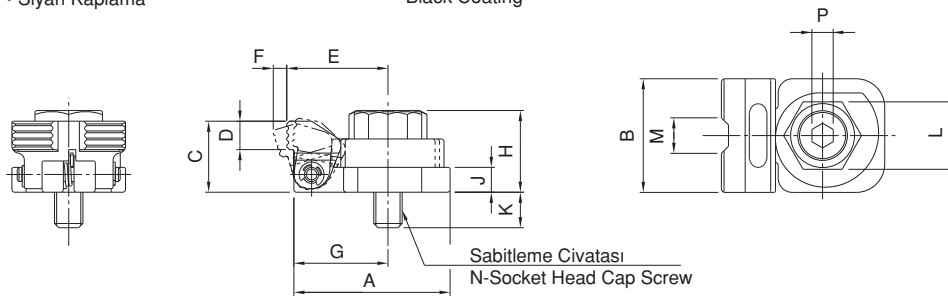

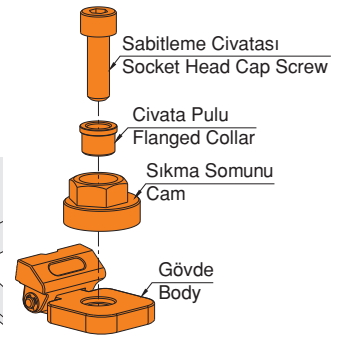
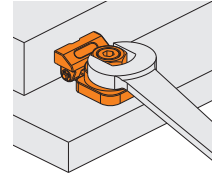

#### Kullanım Şekli / How To Use

- Önce parçayı sabitleyip sonra anahtar ile sıkma işlemi yapılır.
- Secure the body and the flanged collar with a socket head cap screw, and then turn the the cam with a wrench to clamp a workpiece.



## Yandan Bağlama

### Side Clamps

Referans Nr.		A	H	L	S	Sıkma Kuvveti Clamping Force Kgf	 (g)
2080-014	14	61	57	108	5	1500	1850
2080-016	16	61	57	108	5	1500	1850
2080-018	18	61	57	108	5	1500	1850
2080-020	20	61	57	108	5	1500	1850
2080-022	22	61	57	108	5	1500	1850
2080-024	24	61	57	108	5	1500	1850
2080-028	28	61	57	108	5	1500	1850



#### Ürün Nr. 2080 Yandan Bağlama

- Vida kaldırması ile dikey ve yatay sıkma kuvveti sağlamakta.

#### Gövde

- Statik Boya
- Çene
- Sertleştirilmiş



#### Product Nr. 2080 Side Clamps

- Vertical down thrust and horizontal clamping force available simultaneously with the operation of leverage screw

#### Body

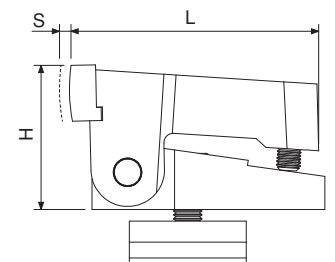
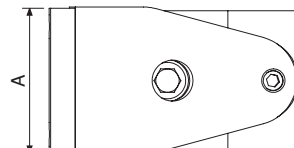
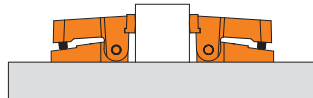
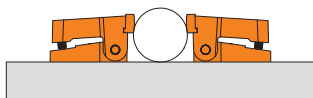
- Static Painting
- Jaw
- Hardened



Referans Nr.		c	b	k1	k2	k3	k4	L	h	h1	d	d1	sıkma kuvveti clamping force Kgf	 (g)
2090-14	14	3.5	30	95	99	26	26	65	28	10	M12	M12	3500	7925
2090-16	16													8490
2090-18	18													4610
2090-20	20													8850
2090-22	22													9030
2090-24	24													9490
2090-28	28													9800







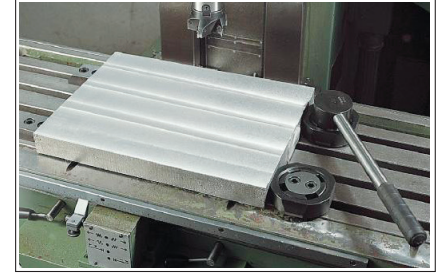
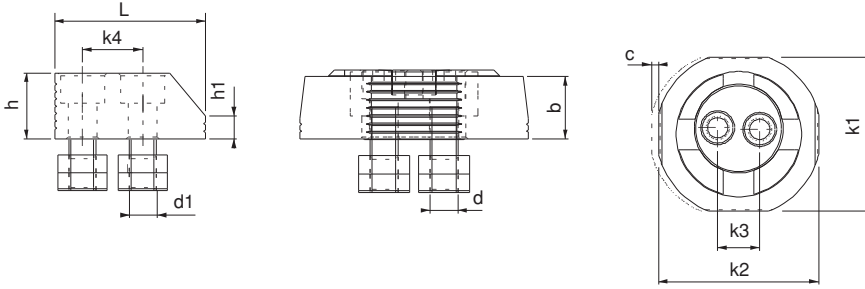

#### Ürün Nr. 2090 Kollu Yandan Bağlama Set

- Ürünün eksantrik çalışma sistemi saat yönünde sıkıldığında iş parçasını dayama ve pleyt yönüne özel dizayn anahtarı ile yüksek kuvvette sıkar.
- 1-Kollu yandan sıkma pabucunun eksantrik hareketi 3.5 mm'dir.
- 2-Ürün iş parçasına 1.5 - 2 mm yakınlaştırılır.
- 3-10 mm alyan ile imbus civataları sabitlenir.
- 4-Ürünü anahtarı ile saat yönünde çevirerek iş parçasını sabitleme işlemi gerçekleştirilir.
- DIN 650 T-Kanala uyumludur
- Somun Sertlik : Sertleştirilmiş
- Siyah kaplama
- Plastik kutuda set

#### Product Nr. 2090 Armed Side Press Set

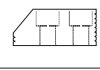
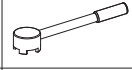
- When the eccentric working system of the product is tightened clockwise, it clamps the work piece with high force in the direction of resting and plate with it's special designed wrench.
- 1-Eccentric movement of Armed Side Clamp 3.5 mm.
- 2-It brings the product 1.5 - 2mm close to the work piece
- 3-imbus bolts are fixed with 10mm allen.
- 4-Fixing of the work piece is implemented by turning the product clockwise with the wrench.
- It is in compliance with DIN 650 T-Slot
- Hardness of nut: Hardened
- Black coating
- Set is in the plastic box



Set İçindekiler / The set consists of							
Parça Part							
Adet Quantity	2	2	1	8	8	1	1

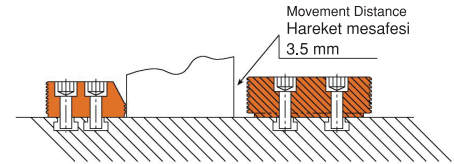

Not: Sabit dayamanın dereceli tarafı ince parçalar, düz tarafı ise kalın parçalarda kullanılmak üzere iki farklı şekilde kullanılabilir.  
Note: Fixed rest can be used as two different ways: Graded side is used for thin pieces and the Straight side is used with thick pieces.

Referans Nr.	
2090-114	14
2090-116	16
2090-118	18
2090-120	20
2090-122	22
2090-124	24
2090-128	28

## Kollu Yandan Bağlama Gövde

### Armed Side Press Body



Referans Nr.	
2040-14	14
2040-16	16
2040-18	18
2040-20	20
2040-22	22
2040-24	24
2040-28	28



## Kollu Yandan Bağlama Dayama

### Armed Side Press Pluggable



Not: Sabit dayamanın dereceli tarafı ince parçalar, düz tarafı ise kalın parçalarda kullanılmak üzere iki farklı şekilde kullanılabilir.  
Note: Fixed rest can be used as two different ways: Graded side is used for thin pieces and the Straight side is used with thick pieces.



Referans Nr.		a1	a2	b	b1	c	h min-max	L	sw	Nm	F1 Sıkma kuvveti Clamping force Kgf	F2 Sıkma kuvveti Clamping force Kgf	 (kg)
2095-571	14-16-18	37	37	57	19	8	78-98	185	10	30	2250	350	3.68
2095-761	20-22-24-28	37	45	76	26	11	98-118	240	14	55	3000	450	7.66

### Ürün Nr. 2095 Blok Yandan Bağlama



- İş parçasını dayama ve pleyt yönüne sıkır özellikle yüksek iş parçaları için tasarlanmıştır
- Çene Sertlik: Sertleştirilmiş
- Siyah kaplama

### Product Nr. 2095 Block Side Press

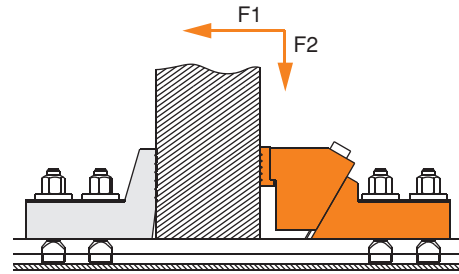
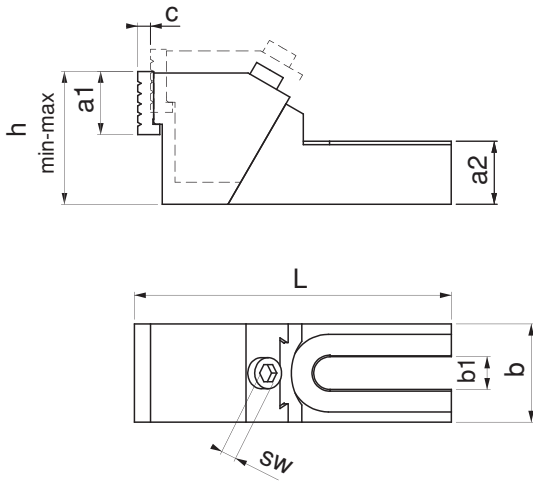
- It clamps the workpieces in clamp rest direction and plate direction, it is designed especially for high workpieces.
- Hardness of jaw: Hardened
- Black coating



## Blok Yandan Bağlama

Referans Nr.		a1	a2	b	b1	c	h min-max	L	sw	Nm	F1 Sıkma kuvveti Clamping force Kgf	F2 Sıkma kuvveti Clamping force Kgf	 (kg)
2095-572	14-16-18	37	37	57	19	8	78-98	185	10	30	2250	350	3.6
2095-762	20-22-24-28	37	45	76	26	11	98-118	240	14	55	3000	450	6.7



### Ürün Nr. 2095 Blok Yandan Bağlama

- İş parçasını dayama ve pleyt yönüne sıkır büyük plakaların bağlanabilmesi için tasarlanmıştır
- Çene Sertlik: Sertleştirilmiş
- Siyah kaplama

### Product Nr. 2095 Block Side Press

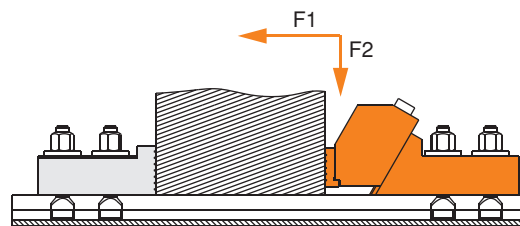
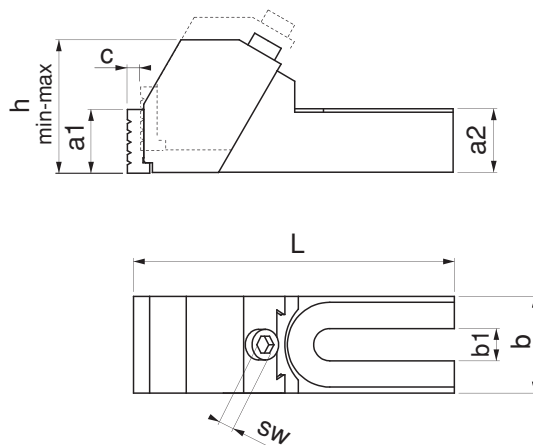
- It clamps the workpieces in clamp rest direction and plate direction, it is designed for clamping big plates.
- Hardness of jaw: Hardened
- Black coating



Referans Nr.		a2	b	b1	h	L	 (kg)
2098-571	14-16-18	37	57	19	85	124	2.025
2098-761	20-22-24-28	45	76	26	105	154	4.185



### Ürün Nr. 2098 Blok Yandan Bağlama Dayaması



- 2095-571 ve 761 pabuçlar için dayama olarak tasarlanmıştır.
- Siyah kaplama

### Product Nr. 2098 Block Stopper Side Press

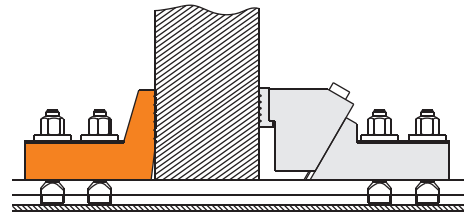
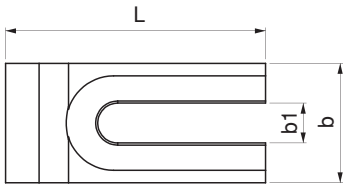
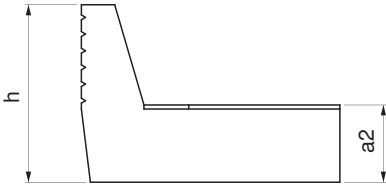
- It is designed as clamp rest for clamps 2095-571 and 761.
- Black coating



## Blok Yandan Bağlama Dayaması

Referans Nr.		a2	b	b1	h	L	 (kg)
2098-572	14-16-18	37	57	19	47	112	2.800
2098-762	20-22-24-28	45	76	26	49	140	4.185

### Ürün Nr. 2098 Blok Yandan Bağlama Dayaması

- 2095-572 ve 762 pabuçlar için dayama olarak tasarlanmıştır.
- Siyah kaplama

### Product Nr. 2098 Block Stopper Side Press

- It is designed as clamp rest for clamps 2095-572 and 762.
- Black coating

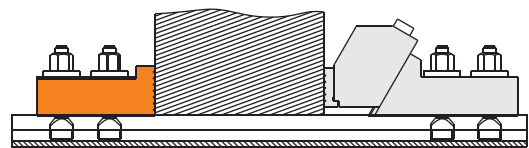
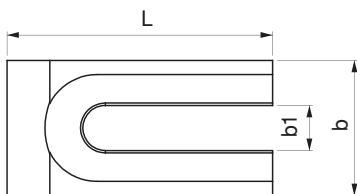
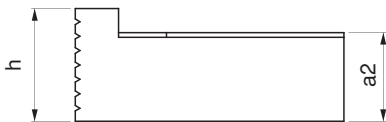

Referans Nr.	a	Sıkma Kuvveti Clamping Force (Kgf)	Nm	(kg)
2105-MYB404114	14	3000	55	2.80
2105-MYB404116	16	3000	55	2.80
2105-MYB404118	18	3000	55	2.80
2105-MYB404120	20	3000	55	2.80
2105-MYB404122	22	3000	55	2.80
2105-MYB404124	24	3000	55	2.80

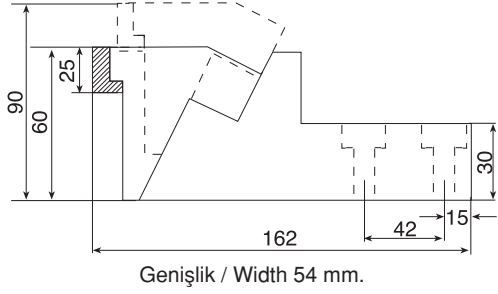
**Ürün Nr. 2105 Blok Yandan Bağlama**  
**Product Nr. 2105 Block Side Press**

Genişlik / Width 54 mm.

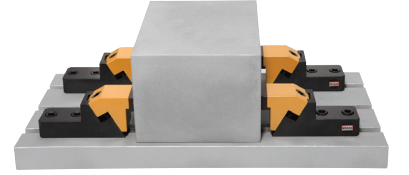
**Blok Yandan Bağlama Dayaması**

Block Stopper Side Press

Referans Nr.	a	(kg)
2105-MD404214	14	1.86
2105-MD404216	16	1.86
2105-MD404218	18	1.86
2105-MD404220	20	1.86
2105-MD404222	22	1.86
2105-MD404224	24	1.86

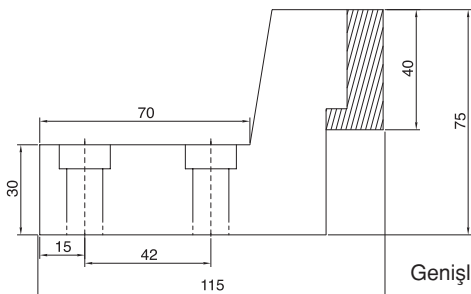
**Ürün Nr. 2105 Blok Yandan Bağlama Dayaması**  
**Product Nr. 2105 Block Stopper Side Press**

Genişlik / Width 54 mm.

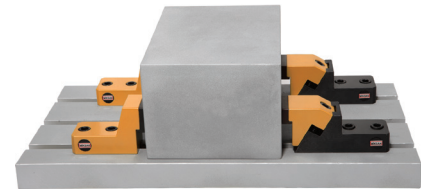

Referans Nr.	a	Sıkma Kuvveti Clamping Force (Kgf)	Nm	(kg)
2105-MYB901120	20	3000	55	6.85
2105-MYB901122	22	3000	55	6.85
2105-MYB901124	24	3000	55	6.85
2105-MYB901128	28	3000	55	6.85

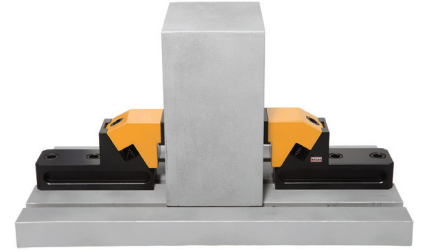
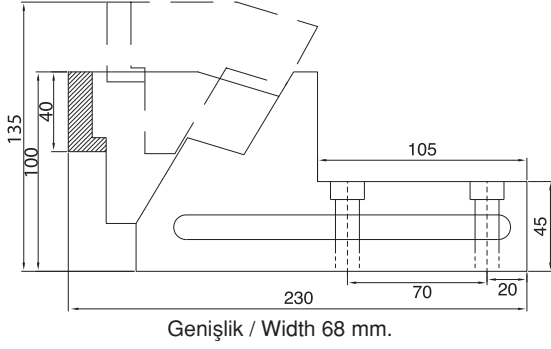
**Ürün Nr. 2105 Blok Yandan Bağlama**  
**Product Nr. 2105 Block Side Press**

Referans Nr.	a	(kg)
2105-MD902120	20	4.50
2105-MD902122	22	4.50
2105-MD902124	24	4.50
2105-MD902128	28	4.50

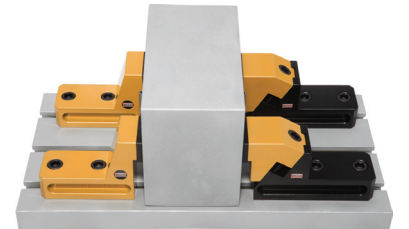
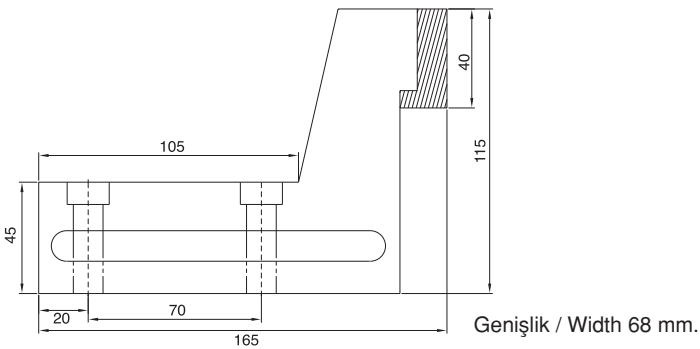
**Ürün Nr. 2105 Blok Yandan Bağlama Dayaması**  
**Product Nr. 2105 Block Stopper Side Press**

Referans Nr.	a	Sıkma Kuvveti Clamping Force (Kgf)	Nm	(kg)
2105-MYB303114	14	3000	55	2.80
2105-MYB303116	16	3000	55	2.80
2105-MYB303118	18	3000	55	2.80
2105-MYB303120	20	3000	55	2.80
2105-MYB303122	22	3000	55	2.80
2105-MYB303124	24	3000	55	2.80

Ürün Nr. 2105 Blok Yandan Bağlama  
Product Nr. 2105 Block Side Press

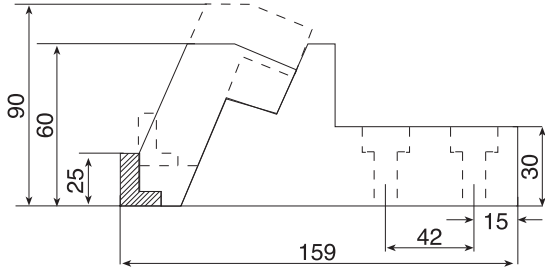

Genişlik / Width 54 mm.

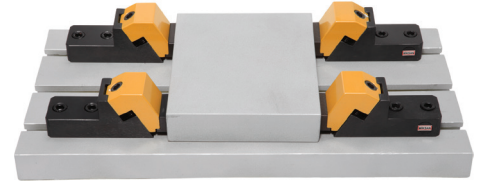

Referans Nr.	a	(kg)
2105-MD303214	14	1.17
2105-MD303216	16	1.17
2105-MD303218	18	1.17
2105-MD303220	20	1.17
2105-MD303222	22	1.17
2105-MD303224	24	1.17

Ürün Nr. 2105 Blok Yandan Bağlama Dayaması  
Product Nr. 2105 Block Stopper Side Press

## Blok Yandan Bağlama Dayaması

Block Stopper Side Press

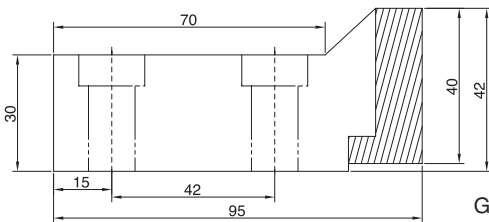

Genişlik / Width 54 mm.

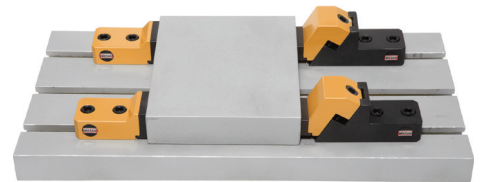

Referans Nr.	a	c	h	b	L	L1	L2	sw	d	Sıkma Kuvveti Clamping Force		(g)
										f1 Kgf	f2 Kgf	
2110-12	12	3	20	40	80	39	26	6	M10	1600	60	415
2110-14	14									2200	90	425
2110-16	16									3200	120	785
2110-18	18	4	25	50	100	46	34	8	M14	3600	140	810
2110-20	20									3600	140	850
2110-22	22									3600	140	2275
2110-24	24	5	28.5	78	140	65	50	10	M20	3600	140	2360
2110-28	28									4000	160	2500

#### Ürün Nr. 2110 Çift Çeneli Yandan Bağlama

- İş parçasını dayama ve pleyt yönünde sıkar, pabucun yapısından dolayı kuvvetli sıkma yapar.
- Sertleştirilmiş
- Siyah kaplama

#### Product Nr. 2110 Side Press Clamp with Double Claw

- Product clamps the work piece in the direction of rest and plate. It achieves powerful clamping because of the clamp's structure.
- Hardened
- Black coating

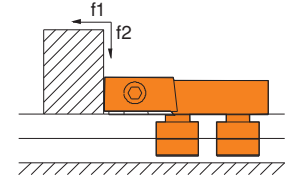
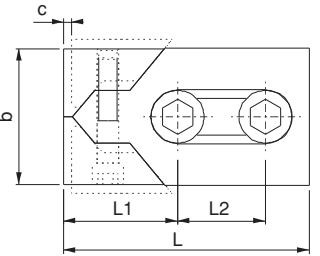
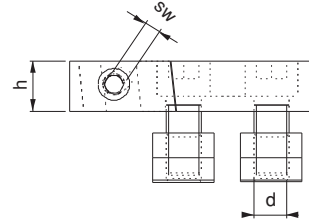

Referans Nr.	a	a h6	b -0.6	c DIN 650	d ±0.01	h1 ±0.01	h1 ±0.02	h2	h3	ISO 4762	(g)
2120-1450	14	0-0.011	14	24	32	-	50	9	8	M8x60	355
2120-1825	18	0-0.011	18	30	40	25	-	15	10	M10x40	360
2120-1850	18	0-0.011	18	30	40	-	50	15	10	M10x65	600
2120-2225	22	0-0.013	22	38	40	25	-	15	14	M10x50	410
2120-2250	22	0-0.013	22	38	40	-	50	15	14	M10x75	650

#### Ürün Nr. 2120 Silindirik Dayama

- Sertleştirilmiş
- Siyah Kaplama

#### Product Nr. 2120 Cylinder Pluggable

- Hardened
- Black coating

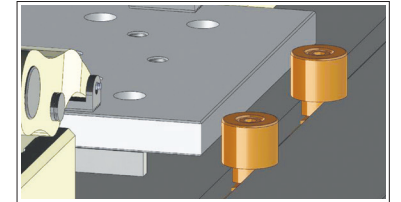
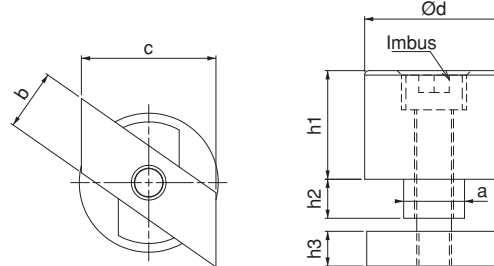

### Silindirik Dayama Cylinder Pluggable



Referans Nr.	a	n	e	c	d	b	h	k	L	sw	(g)
2130-14	14	13.7	22	22	M8	11	4	8	44	6	180
2130-16	16	15.7	25	25	M12	12.5	5	9	50	10	270
2130-18	18	17.7	28	28	M12	14	5	10	56	10	355
2130-20	20	19.7	32	32	M16	16	5	12	64	14	570
2130-22	22	21.7	35	35	M16	17.5	6	14	70	14	770
2130-24	24	23.7	40	40	M20	20	6	16	80	17	1180
2130-28	28	27.7	44	44	M20	22	6	18	88	17	1560

#### Ürün Nr. 2130 Dayama

- Dayama referans alma, uzunlamasına ve enlemesine kullanılır.
- Sertleştirilmiş
- Siyah kaplama

#### Product Nr. 2130 Clamp Rest

- Clamp Rest is used for reference taking, longitudinal and cross-wise.
- Hardened
- Black coating

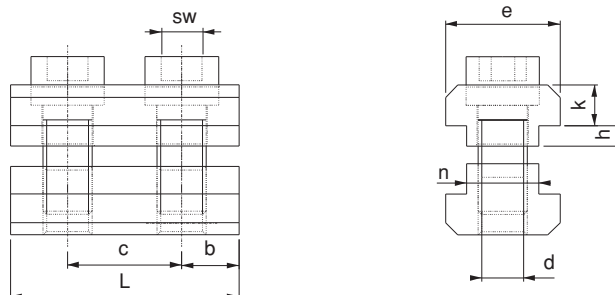

### Dayama Clamp Rest



Referans Nr.	Stopersiz Kullanım In Use Without Slip Stopper		Stoperli Kullanım In Use With Slip Stopper		 (kg)
	Sıkma Kuvveti Clamping Force Kgf	Tork Değeri Allowable Screw Torque (N-m)	Sıkma Kuvveti Clamping Force Kgf	Tork Değeri Allowable Screw Torque (N-m)	
2135-1260	2900	38	6900	90	2.4

M12 civata için 4 adet pul dahildir.  
4 washers for M12 bolts are included.

#### Ürün Nr. 2135 Yandan Bağlama

- Gövde**
- Malzeme: Dökme Demir
  - Siyah kaplama
- Çene**
- Sertleştirilmiş
  - Siyah Kaplama
- Civata**
- Sertlik: İndüksiyon
  - Siyah Kaplama

#### Product Nr. 2135 Side Clamps

- Body**
- Material: Cast Iron
  - Black coating
- Jaw**
- Hardened
  - Black coating
- Bolt**
- Hardness: Induction
  - Black coating

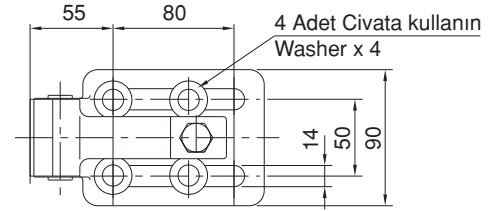
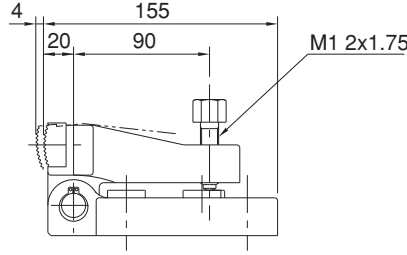
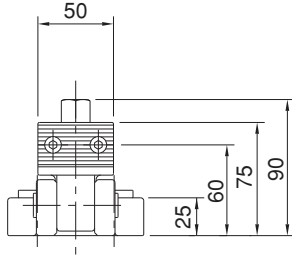

## Yandan Bağlama

### Side Clamps

Referans Nr.	Sıkma Kuvveti Clamping Force Kgf	Tork Değeri Allowable Screw Torque (N-m)	 (kg)
2137-16060	5800	150	2.9

M12 ve M16 vidalar için 2 adet dereceli pul dahildir.  
2 spherical washers for both M12 and M16 screws are included.

#### Ürün Nr. 2137 Yandan Bağlama

- Gövde**
- Malzeme: Dökme Demir
  - Siyah kaplama
- Çene**
- Sertleştirilmiş
  - Siyah Kaplama
- Civata**
- Sertlik: İndüksiyon
  - Siyah Kaplama

#### Product Nr. 2137 Side Clamps

- Body**
- Material: Cast Iron
  - Black coating
- Jaw**
- Hardened
  - Black coating
- Bolt**
- Hardness: Induction
  - Black coating

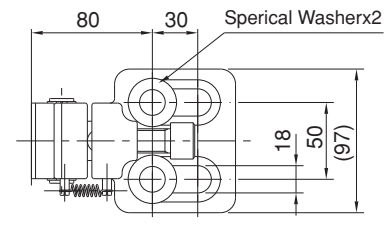
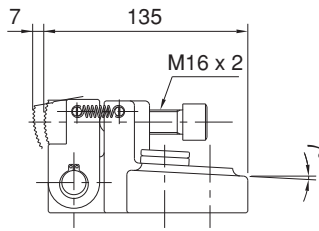
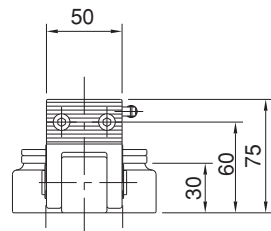

Referans Nr.	W1	W2	H1	H2	M	P1	H4	L4	W	L3	H5	d	L5	P
2139-32150	45	15	27	18	M4x0.7	30	18	13	75	20	8	6.6	3	60
2139-40200	60	20	33	22	M5x0.8	40	22	17	100	26	10	8.6	4	80

Referans Nr.	H	L	L2	R	L1	H3	M1
2139-32150	32	51	48	63	51.5	18	M4x0.7
2139-40200	40	67	63	80	67	22	M5x0.8

Referans Nr.	A	Sıkma Torku Clamping Stroke	Çalışma Yüğü Operating Load (N)	Sıkma Kuvveti Clamping Force Kgf	(g)
2139-32150	19	1.6	150	200	620
2139-40200	24	2.2	200	300	1360



### Ürün Nr. 2139 Tek Dokunuş Yandan Bağlama

- Siyah kaplama

### Product Nr. 2139 Cam Edge Clamps

- Black coating

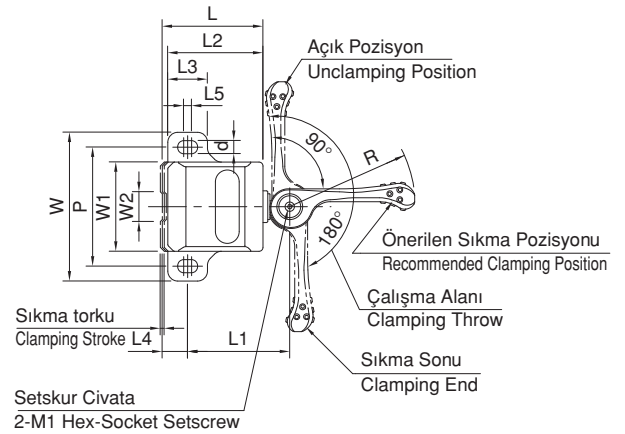
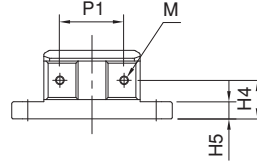
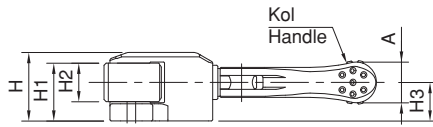

### Özellikler

- Kol ile tek dokunuşta sıkma.
- Finiş işlerde mükemmel bağlama.
- Parçanın kalkmaması için çeneyi aşağı ve ileri iter.

### Features

- The cam handle allows fast clamping in single operation.
- Precision-ground jaw is perfect for clamping the workpiece on its finished surface.
- In clamping, the jaw provides downward force to prevent part lift.

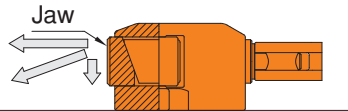

### Kol Konumunu Değiştirme

90 derece 4 opsiyonlu kullanım

### Changing Handle Position

The handle shaft has 4 countersinks which are provided every 90° for 4 options of handle position

### Kullanım Şekli How To Use

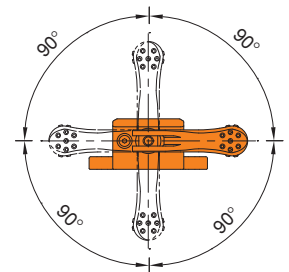
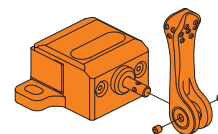
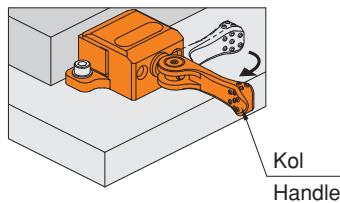



Referans Nr.	Sıkma Torku Clamping Stroke	W1	W2	H3	H4	L2	W	L	H2	d	P	H5	L1
2141-00010	1	38	8	6	3	15	45	33.5	10	5.2	36	5	30.5
2141-00015	2	60	12	9	5	22	70	50	15	8.2	55	7	46

Referans Nr.	H	D	H1	R	A	W3	M1	İzin Verilen Tork Allowable Screw Torque (N m)	Sıkma Kuvveti Clamping Force Kgf	
2141-00010	30	13	20	63	12	6	M4x0.7	10	400	85
2141-00015	46	19	30	100	18	10	M5x0.8	27	600	290

**Ürün Nr. 2141 Yandan Bağlama**

- Gövde**
- Siyah kaplama
  - Çene
  - Sertleştirilmiş
  - Siyah Kaplama

**Product Nr. 2141 Side Clamps**

- Body**
- Black coating
- Jaw**
- Hardened
  - Black coating

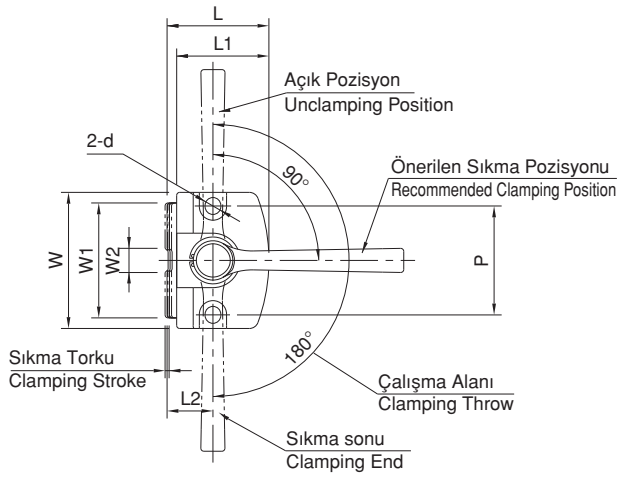
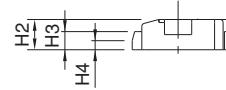
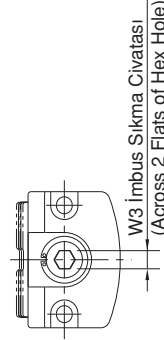
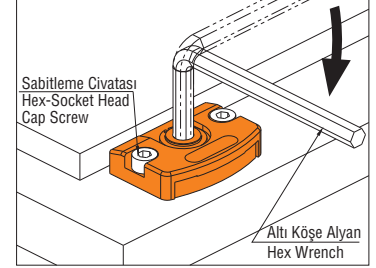
**Kullanım Şekli / How To Use**

Referans Nr.	S	W	W1	H1	L1	P	D (h7)	H2	M	L	H	T	Sıkma Kuvveti Clamping Force Kgf	Tork Değeri Allowable Screw Torque (N-m)	
2143-08015	3	25	10	25	21.5	10	6	7	M8	32	15	1.6	700	25	115
2143-10019	4	30	11	32	26	12	6	7	M10	40	19	2	850	50	225
2143-12023	5	35	12	38	33	16	8	10	M12	50	23	2.3	2000	90	390
2143-16025	6	40	14	45	40	20	10	10	M16	60	25	3.2	3000	150	640

**Yandan Bağlama**

## Side Clamp

**Ürün Nr. 2143 Yandan Bağlama**

- Sertleştirilmiş
- Siyah Kaplama

**Product Nr. 2143 Side Clamps**

- Hardened
- Black coating

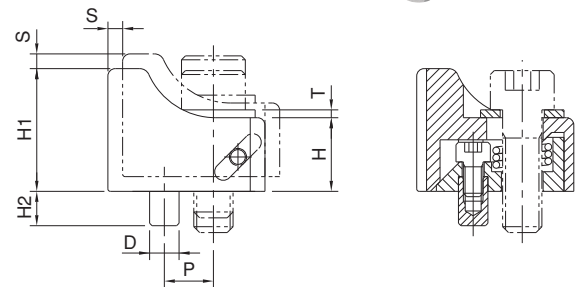
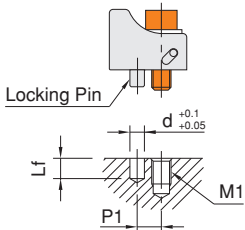
**Kurulum ve Kullanım Şekli / How To Use and Install**

Nr.	M1	d	Lf	P1
CP107-08015	M 8	6	8	10
CP107-10019	M10	8	11	12
CP107-12023	M12	10	14	16
CP107-16025	M16	12	17	20

Üst tarafta görüldüğü gibi sabitlemek için bir pim, bir cıvata deliği gerekli.

Drill a cap-screw hole and a locking-pin hole as specified on the up.

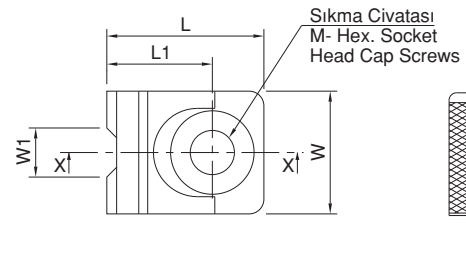
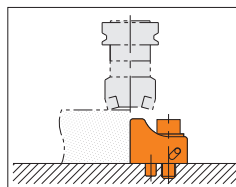

Referans Nr.	s	w	w1	h1	L1	P	d (h7)	h2	M	L	h	t	Sıkma Kuvveti Clamping Force (N)	İzin Verilen Vida Torqu Allowable Screw Torque (N·m)	(g)
2144-08015	3	25	10	6	24.5	10	6	7	M8	35	15	1.6	7.000	25	100
2144-10019	4	30	11	8	29	12	6	7	M10	43	19	2	8.500	50	185
2144-12023	5	35	12	9	37	16	8	10	M12	54	23	2.3	20.000	90	320
2144-16025	6	40	14	10	45	20	10	10	M16	65	25	3.2	30.000	150	520

### Ürün Nr. 2144 Yandan Bağlama

- Sertleştirilmiş
- Siyah kaplama

### Product Nr. 2144 Side Clamp

- Hardened
- Black coating

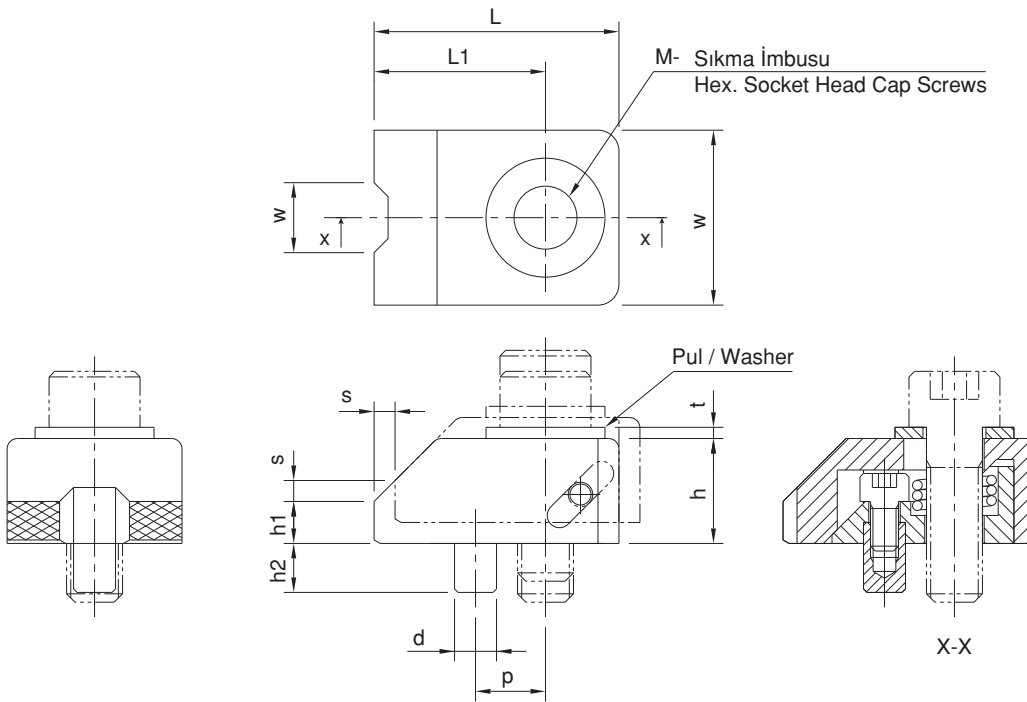

### Uygulama Örneği / Application Example

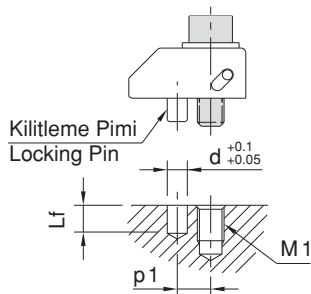

Referans Nr.	M1	d	Lf	p1
2144-08015	M 8	6	8	10
2144-10019	M10	6	8	12
2144-12023	M12	8	11	16
2144-16025	M16	10	11	20

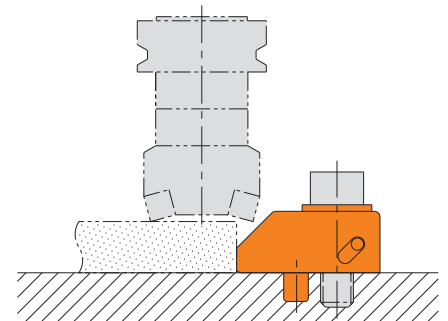

Referans Nr.	a	s1	m	sw	L	h	k	n	b	Sıkma Kuvveti Clamping Force	
										kgf	(g)
2150-08	8	1.4	5	4	23	9.5	6	7.7	13	310	25
2150-10	10	1.4	5	4	23	14	6	9.7	15	310	35
2150-12	12	1.2	7	5	28	15	7	11.7	18	340	60
2150-14	14	1.7	7	7	30	22	8	13.7	22	800	95
2150-16	16	1.7	10	8	30	22	9	15.7	25	1500	130
2150-18	18	2	10	8	35	28	10	17.7	28	1500	190
2150-20	20	2.5	13	10	40	32	12	19.7	32	2000	290
2150-22	22	2.5	13	12	45	38	14	21.7	35	2000	390

#### Ürün Nr. 2150 Kanal İçi Yandan Bağlama

- Ürünün T-Gövdesi tamamıyla tezgah kanalına girer. Sadece ürünün eksantrik başlığı tabla yüzeyinde kaldığı için ince parçalarda sıkma kolaylığı sağlar.
- DIN 650 T-Kanala uyumludur
- Sertleştirilmiş
- Siyah kaplama

#### Product Nr. 2150 In-slot Side Clamp

- T-Slot of the product enters in the slot of the bench completely. Since only the eccentric headpiece remains on the surface of the table, this provides easy clampings of the thin pieces.
- It is in compliance with DIN 650 T-Slot
- Hardened
- Black coating

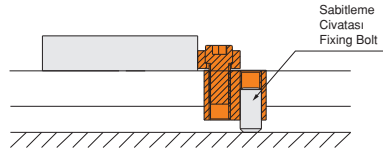
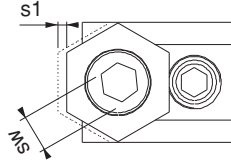
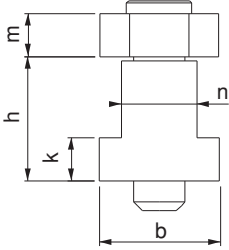
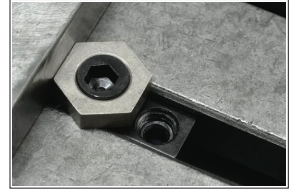

## Yandan Bağlama Pençe Pabuç

### Jaw Clamp

Referans Nr.	a	c	n		x	L	b	m1	sw	Sıkma Kuvveti Clamping Force		(g)
			min	max						f1 kgf	f2 kgf	
2170-12	12	2	2	6	4	46	21	10	5	500	60	120
2170-14	14	2.5	2.5	7.5	5	51	26	10	6	550	70	200
2170-16	16	3	2.5	8.5	6	61	27.5	12	6	800	90	290
2170-18	18	3	2	8	6	67	35	13	8	900	100	420
2170-20	20	4	2.5	11	8.5	78	38	13	10	1200	140	640
2170-22	22	4.5	2.5	12	9.5	87	39	16.5	10	1600	190	830



#### Ürün Nr. 2170 Yandan Bağlama Pençe Pabuç

- İş parçasını dayama ve pleyt yönüne sıkır
- T-Kanal içinde çalışması yükseklik avantajı sağlar
- DIN 650 T-Kanala uyumludur
- Sertleştirilmiş
- Siyah kaplama

#### Product Nr. 2170 Jaw Clamp

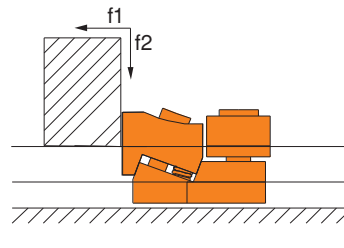
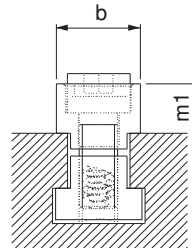
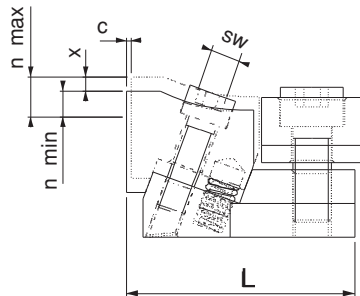
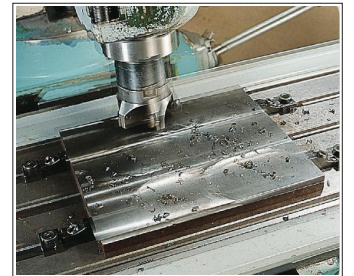
- This product clamps the workpiece in the direction of resting and plate
- It's working in T-Slot provides height advantage
- It is in compliance with DIN 650 T-Slot
- Hardened
- Black coating



Referans Nr.	c			m	k	b	L	e DIN 912	Nm	Sıkma Kuvveti Clamping Force kgf	
	min	max									
2190-5055	50	55	14-16-18-20-22	35	4	30	42	M12	35	1750	390

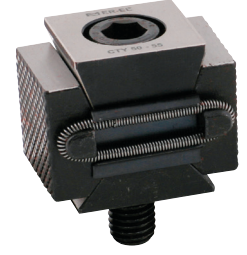

#### Ürün Nr. 2190 Çift Açılır Yandan Bağlama

- Bir noktadan iki yöne ve pleyt yönüne doğru sıkma işlemi yapar.
- M12 diş pleytlerde ve (a) 14-16-18-20-22 T-Kanal ölçülerinde kullanılır.
- Sertleştirilmiş
- Siyah kaplama

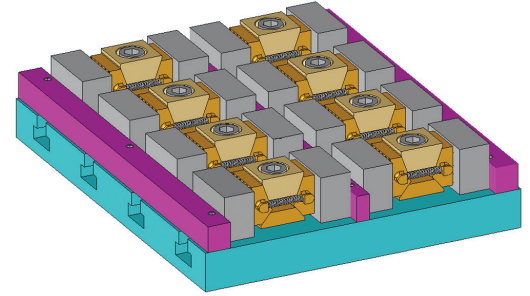
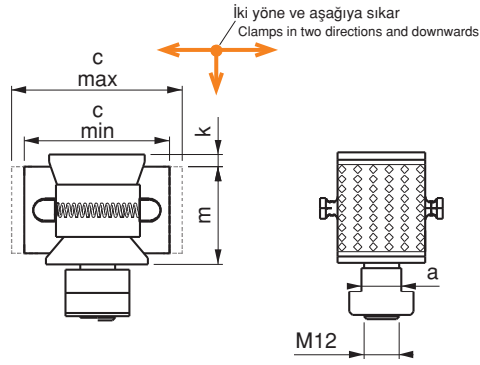

#### Product Nr. 2190 Side Press with Double Opening

- This product makes press process from one point to two directions and towards the direction of the plate.
- It is used in M12 thread plates and (a) 14-16-18-20-22 T-Slot measurings
- Hardened
- Black coating



## Çift Açılır Yandan Bağlama

### Side Press with Double Opening

Referans Nr.	c			m	k	b	L	e DIN 912	Nm	Sıkma Kuvveti Clamping Force kgf	
	min	max									
2210-4954	49	54	14-16-18-20-22	23	4	30	42	M12	55	1500	280

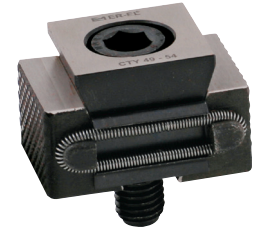

#### Ürün Nr. 2210 Çift Açılır Yandan Bağlama

- Bir noktadan iki yöne sıkma işlemi yapar.
- M12 diş pleytlerde ve (a) 14-16-18-20-22 T-Kanal ölçülerinde kullanılır.
- Sertleştirilmiş
- Siyah kaplama

#### Product Nr. 2210 Side Press with Double Opening

- This product makes press process from one point to two directions.
- It is used in M12 thread plates and (a) 14-16-18-20-22 T-Slot measurings
- Hardened
- Black coating

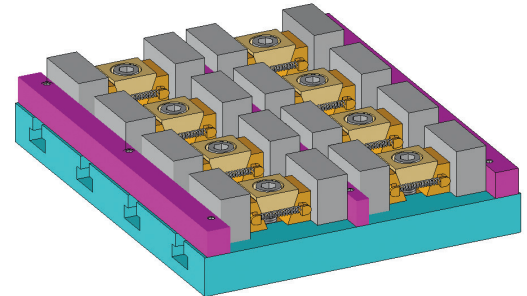
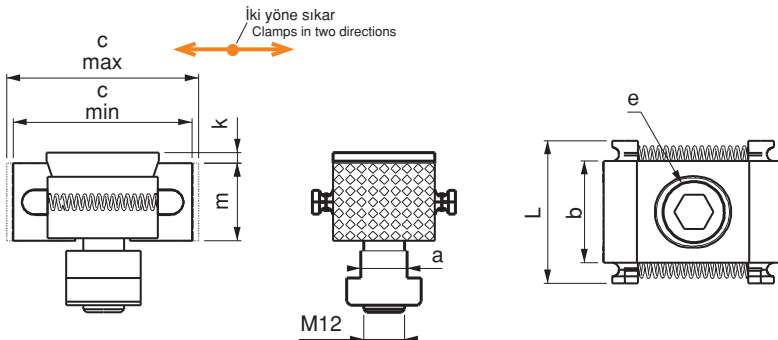

Referans Nr.	h x b x L	tolerans tolerance h	tolerans tolerance b	(kg)	Adet Piece
2230-028	14x10x150	±0.01	±0.01	10.8	2
	16x10x150				2
	18x10x150				2
	20x10x150				2
	22x10x150				2
	24x10x150				2
	26x10x150				2
	28x10x150				2
	30x10x150				2
	32x10x150				2
	35x10x150				2
	40x10x150				2
	45x10x150				2
50x10x150	2				

**Ürün Nr. 2230 Paralel Set-28**

- Ürün iş parçalarının paralel bağlanmasında ve hassas işlenmesinde altlık olarak kullanılır.
- 28 parça
- Sertleştirilmiş
- Ahşap kutuda set

**Product Nr. 2230 Parallel Set-28**

- This product is used for parallel coupling of the workpieces and as the base for sensitive machinings of the work pieces.
- 28 pieces.
- Hardened
- Set is in the wooden box

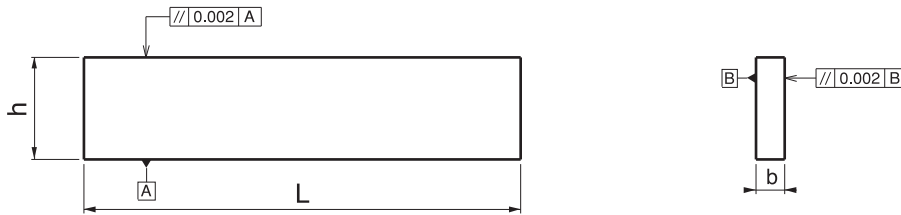
**Paralel Set**

## Parallel Set

Referans Nr.	h x b x L	tolerans tolerance h	tolerans tolerance b	(kg)	Adet Piece
2250-016	20x6x100	±0.01	±0.01	10.6	2
	23x8x100				2
	28x10x100				2
	36x12x150				2
	42x14x150				2
	48x16x150				2
	58x18x150				2
	65x22x150				2

**Ürün Nr. 2250 Paralel Set-16**

- Ürün iş parçalarının paralel bağlanmasında ve hassas işlenmesinde altlık olarak kullanılır.
- 16 parça
- Sertleştirilmiş
- Ahşap kutuda set

**Product Nr. 2250 Parallel Set-16**

- This product is used for parallel coupling of the workpieces and as the base for sensitive machinings of the work pieces.
- 16 pieces.
- Hardened
- Set is in the wooden box

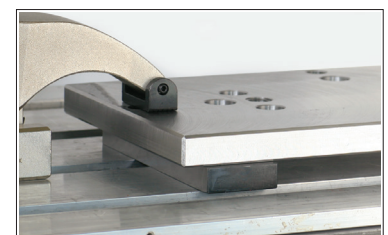
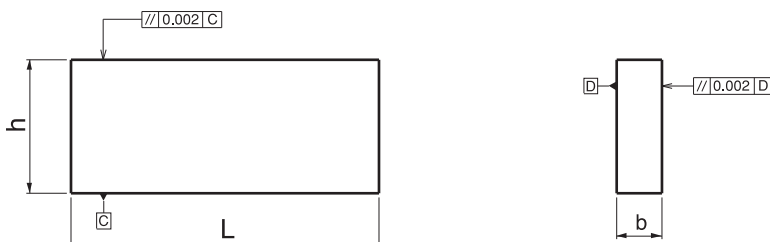

Referans Nr.	a	b	c	Øv		g
				min	max	
2270-140	140	82	40	20	110	1980
2270-204	204	115	66	15	150	6150

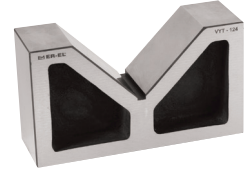

**Ürün Nr. 2270 V-Yatak**

- Malzeme : Döküm
- Silindir parçaların paralel bağlanmasında ve hassas işlenmesinde altlık olarak kullanılır.
- İkili takım

**Product Nr. 2270 V-Clamping Block**

- Material: Casting
- This product is used in parallel couplings of cylindrical pieces and it is also used as the base for sensitive machinings of the workpieces.
- Set of two pieces

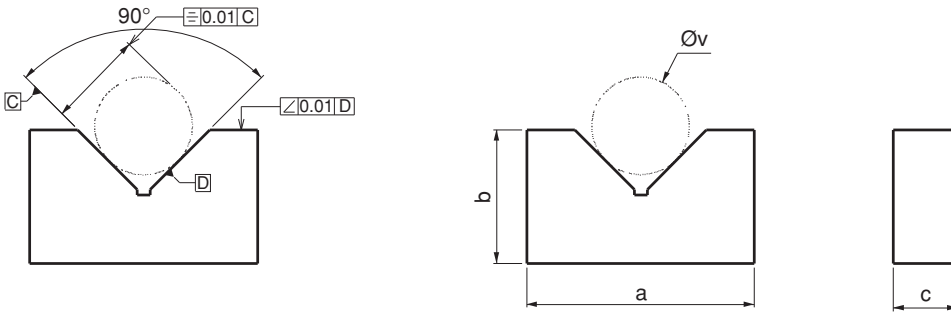

**XV-Yatak**

XV-Clamping Block

Referans Nr.	a	b	c	Øv1		Øv2		Øv3		Øv4		g
				min	max	min	max	min	max	min	max	
2290-120	120	100	60	12	40	12	60	12	75	12	90	2840
2290-150	152	132	74	15	80	15	95	15	110	15	120	4975



**Ürün Nr. 2290 XV-Yatak**

- Malzeme : Döküm
- Silindir parçaların paralel bağlanmasında hassas işlenmesinde altlık olarak kullanılır, X formunda olmasından dolayı 4 ayrı yüzeyi kullanma avantajı sağlar.
- İkili takım

**Product Nr. 2290 XV-Clamping Block**

- Material: Casting
- This product is used in parallel couplings of cylindrical pieces and it is also used as the base for sensitive machinings of the workpieces. It provides using advantage in 4 different surfaces because of being in X form.
- Set of two pieces

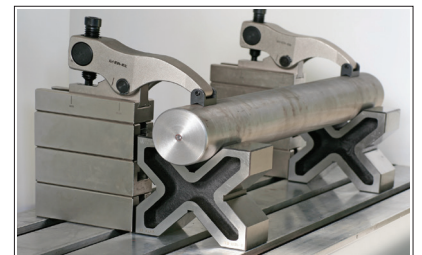
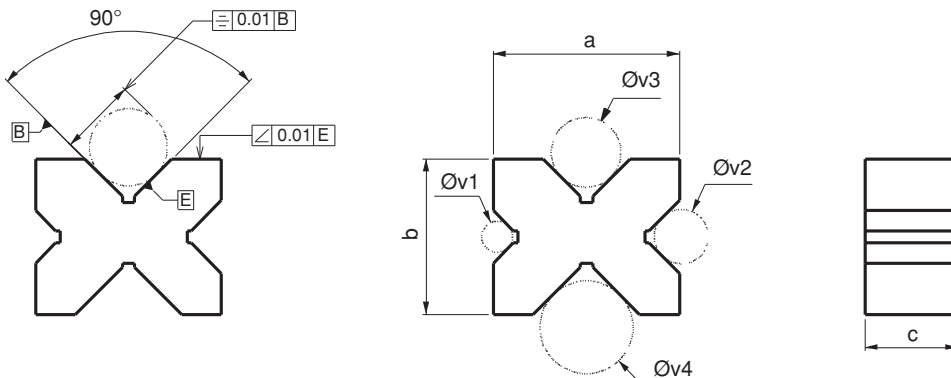

# UYGULAMA ÖRNEKLERİ

APPLICATION EXAMPLES

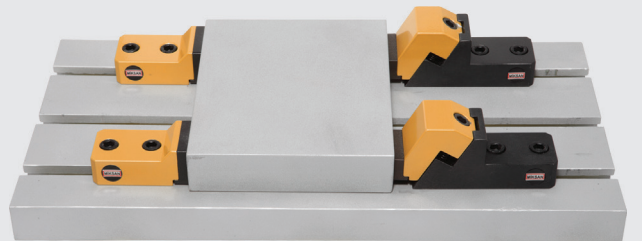
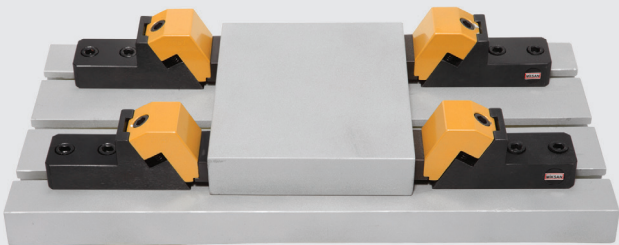
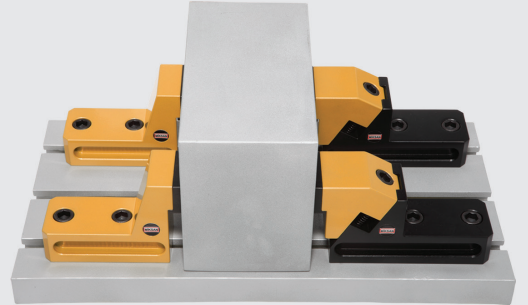
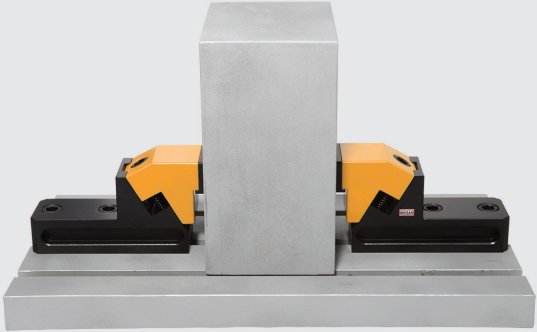
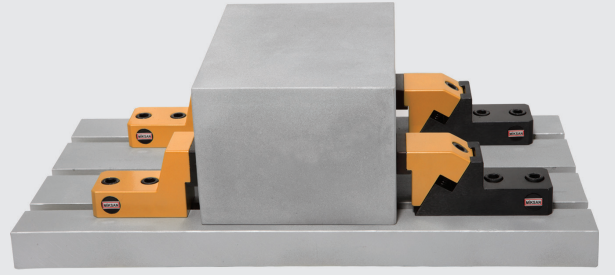
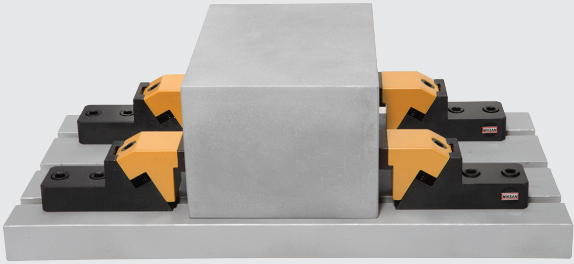

Referans Nr.	d	d1	h	h1	L	(kg)
2385-130	48	32	91	60	151	3.05

## Ürün Nr. 2385 Hassas Delik İşleme Aparatı

- Ürün 0.01 işleme hassasiyetli olup 9mm'den 130mm çapa 145 mm derinliğe işlem yapabilir değiştirilebilir bara ve kartuş özelliği ile mükemmel kullanıma sahiptir.

## Product Nr. 2385 Precision Hole Making Tool

- It works with 0.01 sensitivity in diameter 9-130 mm and 145 mm depth. Because of replaceable function kater and cartouche it is perfect in using.

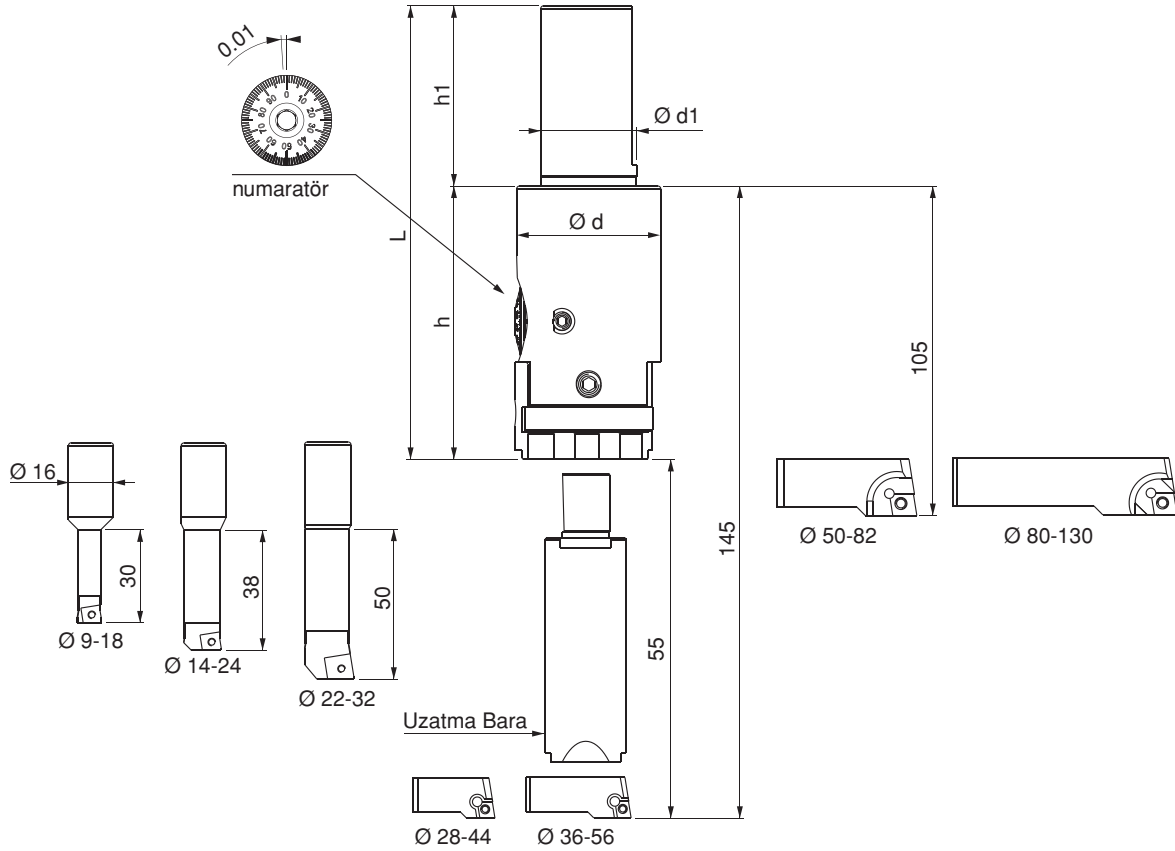

**Not:**  
Ø 52 den sonra  
gövdeyle 105 mm  
uzatma barayla  
145 mm  
derinliğe ulaşır.

Note: from diameter 52: It reaches 105 mm depth with its slot and 145 mm depth with its extended kater

Referans Nr.	Cinsi Type	Uç Tipi Type of Inserts	Devir Rotation	İlerleme Progress	ap
2386-00918	09-18 Bara	CCMT 06	2700 d/dk.	F 75	0.1 - 0.5 mm
2386-01424	14-24 Bara	CCMT 06	2500 d/dk.	F 75	0.1 - 0.5 mm
2386-02232	22-32 Bara	CCMT 09	2000 d/dk.	F 50	0.1 - 1 mm
2386-02844	28-44 Kartuş	CCMT 06	1800 d/dk.	F 60	0.1 - 1 mm
2386-03656	36-56 Kartuş	CCMT 06	1500 d/dk.	F 65	0.1 - 1.5 mm
2386-05082	50-82 Kartuş	CCMT 09	1500 d/dk.	F 70	0.1 - 2 mm
2386-80130	80-130 Kartuş	CCMT 09	360 d/dk.	F 75	2 mm
2386-00055	Uzatma Bara	-	400 d/dk.	F 75	1.5 mm



Referans Nr.	J x M	k	h	h1	e	L	L1	L2	
2390-010	ISO30-M12	83	99	35	18	85	128	26	6030
2390-015	ISO40-M16								6555
2390-020	ISO50-M24								9110
2390-025	BT40 -M16								6900
2390-030	BT50 - M24								9840
2390-035	SK40- M16								6750
2390-040	SK50- M24					8970			
2390-045	MK4 - M16					132	6180		
2390-050	MK4 Kamalı					6880			
2390-055	MK5 - M20					7785			
2390-060	MK5 Kamalı					7450			

### Ürün Nr. 2390 Delik İşleme Aparatı

- Ürün 0.02 işleme hassasiyetli olup 18mm'den 210mm'ye kadar işlem yapabilir.
- Modüler sistem oluşu kullanım için kolaylık sağlar.
- Tutucu değiştirilerek CNC ve Mekanik tezgahlarda kullanım avantajı sağlar.
- Ürün, 4 ad. delik barası, 1 ad. T-Kanal temizleyici ile ahşap kutudadır.
- Değiştirilebilir Tutucular:
- ISO-30-40-50 BT40-50 SK40-50 MK4-5 ile kullanım imkanı.

### Product Nr. 2390 Hole Machining Apparatus

- Product has 0.02 machining sensitivity and it can implement processes from 18mm to 210mm.
- It's modular system structure provides convenience in using.
- It provides the possibility of using in CNC and Mechanical benches by changing the holder.
- The product takes place in a wooden box with it's 4 hole bar, 1 T-Slot scraper.
- Changeable Holders:
- Possibility to be used with ISO30-40-50 BT 40-50 SK40-50 MK4-5.

Modülerdir, sabitleme işlemi saat yönüne doğru vidalanarak yapılır.  
It is modular. Fixing process is done screwing towards clockwise

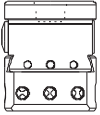
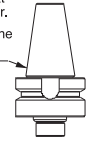

Referans Nr.	L	L1	e	Kesici uç tipi Cutting Edge type	
2395-1	85	-	18	DCMT 07	112
2395-2	95	-	18	DCMT 07	130
2395-3	132	-	18	DCMT 07	200
2395-4	-	128	18	-	360

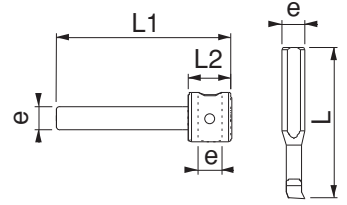
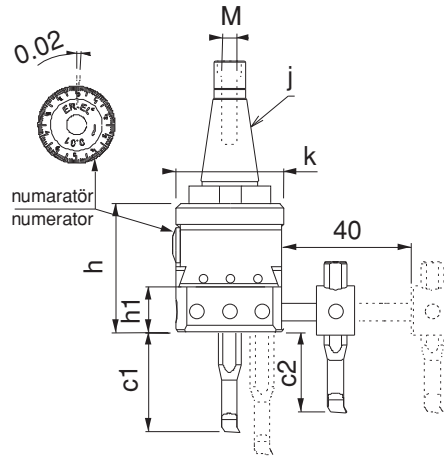

min	Ø	max	c1	devir dk. Revolution per minute
18		95	50	400-450
18		95	63	400-450
20		100	100	170-220



- Ürünün kazağındaki alt deliklerine baraları takarak 18mm'den 100mm çapa kadar büyütme 0-100mm kadar derinliğe inebilir.
- It is possible to have enlargement from 18mm to 100mm by attaching bars to the bottom holes taking place in the slide of the product and it can go down to depth up to 0-100mm.



min	Ø	max	c2	devir dk. Revolution per minute
95		210	55	90-170
95		210	65	90-170



- Ürünün kazağındaki yan deliğe ara vasatı takarak, şekilde görüldüğü gibi 95mm'den - 210mm çapa kadar büyütme, 0-65mm kadar derinliğe inebilir
- By applying intermediary means to the side hole of the product's slide, it is possible to have enlargement from 95mm to 210mm and it can go down to depth up to 0-65mm as seen in the figure.



# UYGULAMA ÖRNEKLERİ

APPLICATION EXAMPLES

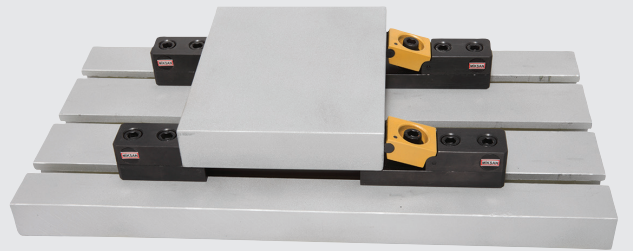
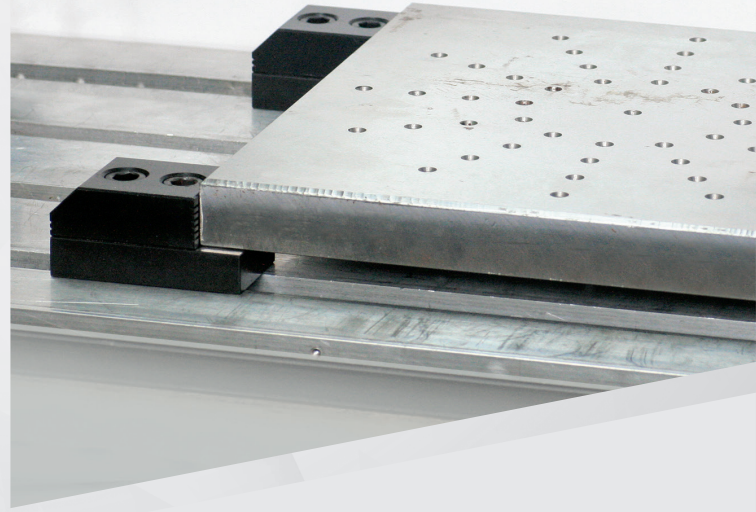
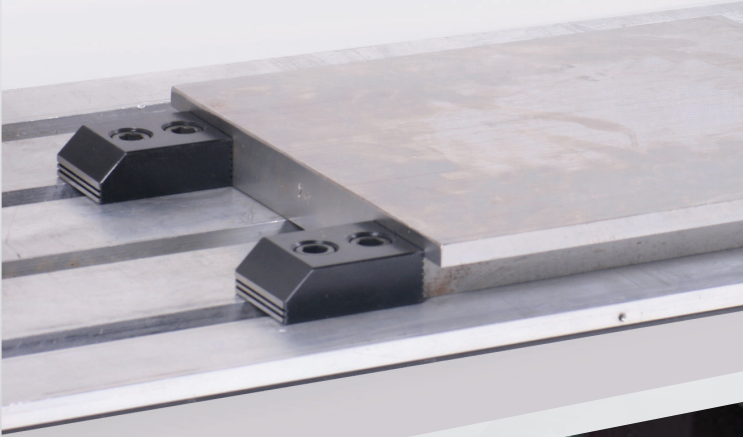
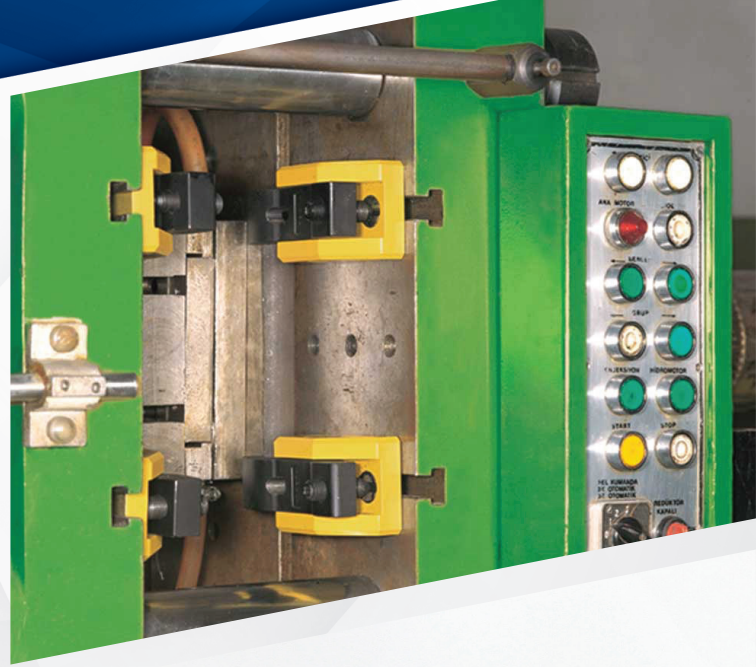
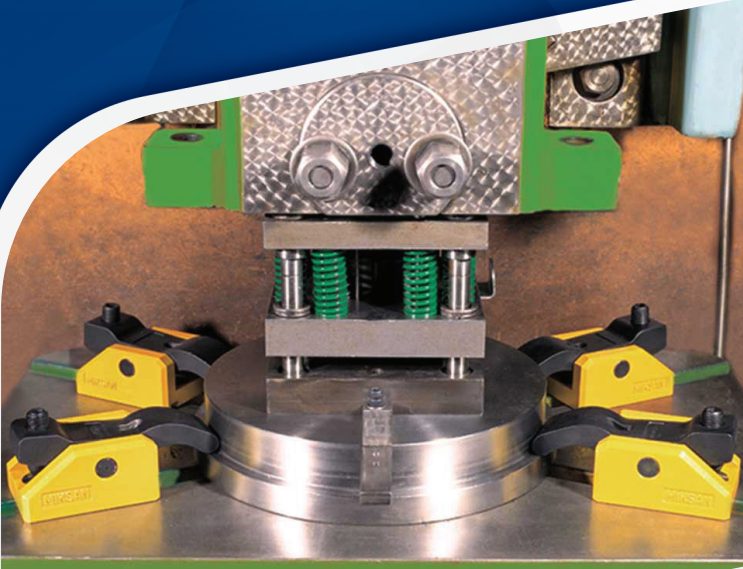



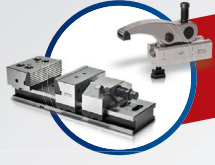

**Standart Ürünler**  
Standard Products



**Tek Dokunuş Bağlamalar**  
Single Touch Clamps



**5-Eksen Blok Bağlama Sistemi**  
5-Axis Clamping Block System



**Hidrolik Komponentler**  
Hydraulic Components



**Hızlı Kalıp Değişirme Sistemi**  
Quick Mold Change System



**Proje Bazlı Fikstür Uygulamaları**  
Project Based Fixture Applications



**ER-EL Zero Sistem**  
ER-EL Zero Point Clamping System



**MİKSAN**  
Standard Products

**Bağlama ekipmanlarında  
kalite üretiyoruz..**

*"We produce quality in clamping equipment"*

45'i aşkın ülkeye ihracat yapıyoruz..  
We export to more than 45 countries

**ER-EL®**

ER-EL MAKİNA YEDEK PARÇA İML. SAN. VE TİC. LTD. ŞTİ.

Çerkeşli OSB Mah. İMES 3 Blv. No: 14 Dilovası - Kocaeli  
Tel: +90 262 502 11 60 Pbx Fax: +90 262 502 11 59  
info@er-el.com.tr [www.er-el.com.tr](http://www.er-el.com.tr)



erelkalip  
miksanc.clamp



ERELkalip  
ClampMiksan



erelkalip  
miksanc.clamp



erelkalip



er-el-kalip

