

MIKSAN®

Hızlı Bağlama Sistemleri

MIKSAN bir **ER-EL** markasıdır.

**Bağlama ekipmanlarında
kalite üretiyoruz..**

"We produce quality in clamping equipment"



20 **22 KATALOG**
23 CATALOGUE

MİKSAN®

Hızlı Bağlama Sistemleri

MİKSAN bir ER-EL markasıdır.



30 yıldır ülkemizde ve Yurtdışında kalıp bağlama elemanları üreticisi olarak sektöre hizmet veren MİKSAN Hızlı Bağlama Sistemleri firması 15.Ekim.2019 tarihi itibariyle satın alınarak ER-EL Kalıp Bağlama ve İşleme Sistemleri firmamız bünyesine katılmıştır.

ER-EL markası olan MİKSAN ürünleri; firmamız kalite ve güvencesiyle hizmet vermeye devam edecektir.

MIKSAN Fast Coupling Systems company which has been serving to the sector as a manufacturer of mold fasteners in our country and abroad for 30 years has been purchased as of 15th of October, 2019 and ER-EL Mold Clamping and Processing Systems has joined our company.

MIKSAN products which are ER-EL brand; Our company will continue to serve with quality and assurance.

Referans Nr.	a	Sıkma Kuvveti Clamping Force	Nm	(kg)
1168-MB101112	12	1000	160	1.70
1168-MB101114	14	1000	160	1.70
1168-MB101116	16	1000	160	1.70
1168-MB101118	18	1000	160	1.70
1168-MB101120	20	1000	160	1.70

Ürün Nr. 1168 Kombine Bağlama Pabucu
Product Nr. 1168 Combined Clamp

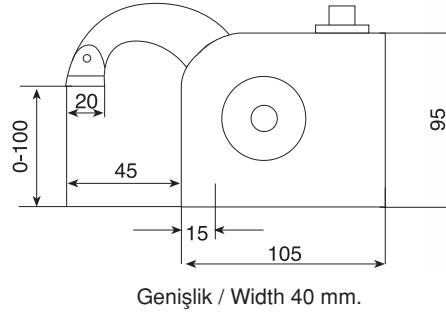

Kombine Bağlama Pabucu

Combined Clamp

Referans Nr.	a	Sıkma Kuvveti Clamping Force	Nm	(kg)
1168-MBU103112	12	1000	160	1.80
1168-MBU103114	14	1000	160	1.80
1168-MBU103116	16	1000	160	1.80
1168-MBU103118	18	1000	160	1.80
1168-MBU103120	20	1000	160	1.80

Ürün Nr. 1168 Kombine Bağlama Pabucu
Product Nr. 1168 Combined Clamp

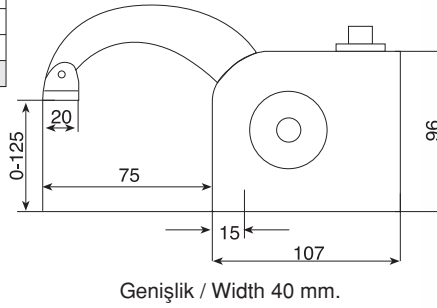

Kombine Bağlama Pabucu Alt Destek

Combined Clamp Bottom Support

Referans Nr.	a	(kg)
1168-MK1021	16	1.80

Ürün Nr. 1168 Kombine Bağlama Pabucu Alt Destek
Product Nr. 1168 Combined Clamp Bottom Support

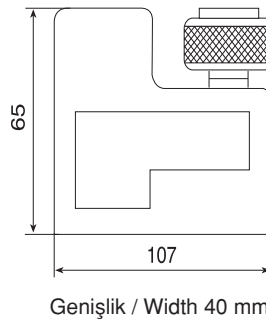

Kombine Bağlama Pabucu Alt Destek

Combined Clamp Bottom Support

Referans Nr.	a	(kg)
1168-MK1022	16	1.10

Ürün Nr. 1168 Kombine Bağlama Pabucu Alt Destek
Product Nr. 1168 Combined Clamp Bottom Support

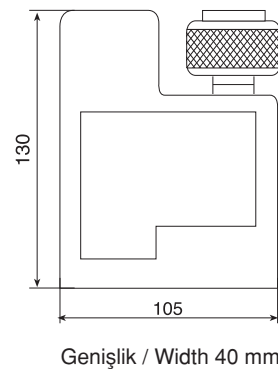

Uygulama Örneği
Example Application



Referans Nr.	a	Sıkma Kuvveti Clamping Force	Nm	(kg)
1168-MFB204112	12	1000	160	1.70
1168-MFB204114	14	1000	160	1.70
1168-MFB204116	16	1000	160	1.70
1168-MFB204118	18	1000	160	1.70
1168-MFB204120	20	1000	160	1.70

Ürün Nr. 1168 Kombine Bağlama Pabucu
Product Nr. 1168 Combined Clamp

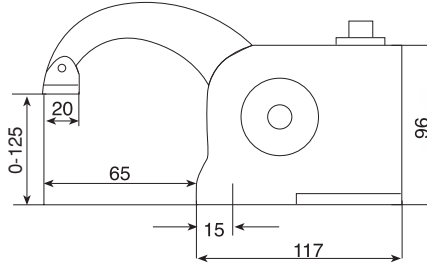

Genişlik / Width 40 mm.



Kombine Bağlama Pabucu Alt Destek

Combined Clamp Bottom Support

Referans Nr.	a	(kg)
1168-MFK204212	12	0.80
1168-MFK204214	14	0.80
1168-MFK204216	16	0.80
1168-MFK204218	18	0.80
1168-MFK204220	20	0.80

Ürün Nr. 1168 Kombine Bağlama Pabucu
Product Nr. 1168 Combined Clamp



Uygulama Örneği
Example Application

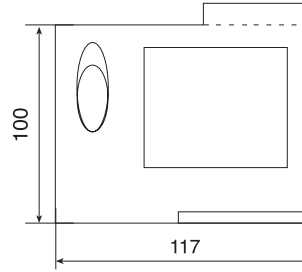

Genişlik / Width 40 mm.



Kombine Bağlama Pabucu

Combined Clamp

Referans Nr.	a	Sıkma Kuvveti Clamping Force	Nm	(kg)
1168-MEP501116	16	2000	110	2.80
1168-MEP501118	18	2000	110	2.80
1168-MEP501120	20	2000	110	2.80
1168-MEP501122	22	2000	110	2.80
1168-MEP501124	24	2000	110	2.80

Ürün Nr. 1168 Kombine Bağlama Pabucu
Product Nr. 1168 Combined Clamp

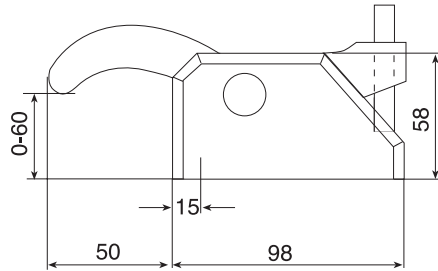

Genişlik / Width 72 mm.



Kombine Bağlama Pabucu Alt Destek

Combined Clamp Bottom Support

Referans Nr.	a	(kg)
1168-MPK5022	18	0.90

Ürün Nr. 1168 Kombine Bağlama Pabucu Alt Destek
Product Nr. 1168 Combined Clamp Bottom Support



Uygulama Örneği
Example Application

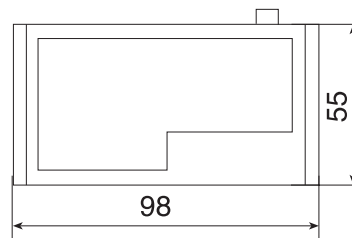

Genişlik / Width 72 mm.



Referans Nr.		Sıkma Kuvveti Clamping Force	Nm	
1168-MP601214	14	2000	130	2.50
1168-MP601216	16	2000	130	2.50
1168-MP601218	18	2000	130	2.50
1168-MP601220	20	2000	130	2.50

Ürün Nr. 1168 Kombine Bağlama Pabucu

- Pabucun çift taraflı kullanım özelliği; kendi içinde bulunan yükseltici desteği ile kısıtlı alanlarda kullanım kolaylığı sağlar.

Product Nr. 1168 Combined Clamp

- Double-sided usage of the clamp and it's stepped lifter provides using advantage in restricted areas

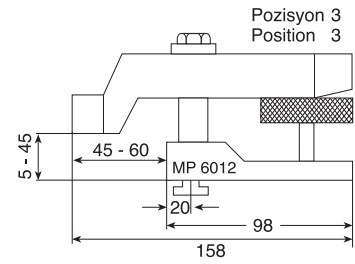
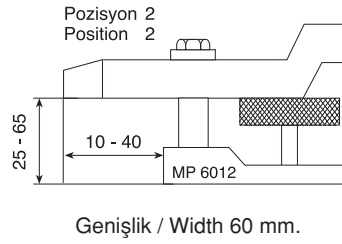
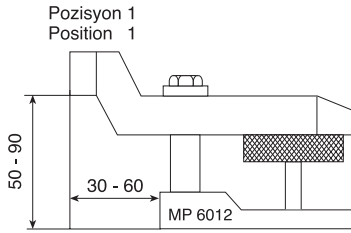

Genişlik / Width 60 mm.



Kombine Bağlama Pabucu Alt Destek

Combined Clamp Bottom Support

Referans Nr.		
1168-MY602114	14	0.60
1168-MY602116	16	0.60
1168-MY602118	18	0.60
1168-MY602120	20	0.60

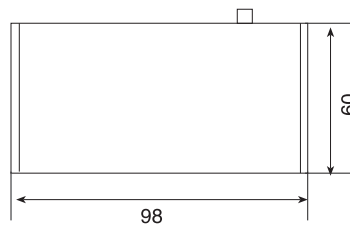

Ürün Nr. 1168 Kombine Bağlama Pabucu Alt Destek

Product Nr. 1168 Combined Clamp Bottom Support



Genişlik / Width 58 mm.

Uygulama Örneği
Example Application

Referans Nr.		Sıkma Kuvveti Clamping Force	Nm	
2070-MBS701214	14	2500	60	3.14
2070-MBS701216	16	2500	60	3.14
2070-MBS701218	18	2500	60	3.14
2070-MBS701220	20	2500	60	3.14

Ürün Nr. 2070 Yandan Bağlama Set

- Mafsallı tasarımıyla düz olmayan yüzeylerde dahi mevcut yüzey şeklini alarak emniyetli bağlama yapar.

Product Nr. 2070 Side Wrench Set

- With its articulated design, it makes safe bonding even on uneven surfaces by taking the existing surface shape.

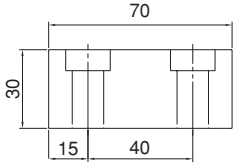

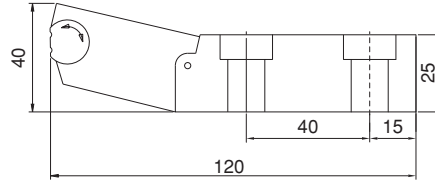

Genişlik / Width 40 mm.



Genişlik / Width 40 mm.



Yandan Bağlama Gövde

Referans Nr.		
2070-MS701114	14	0.87
2070-MS701116	16	0.87
2070-MS701118	18	0.87
2070-MS701120	20	0.87

Ürün Nr. 2070 Yandan Bağlama Gövde



- Mafsallı tasarımıyla düz olmayan yüzeylerde dahi mevcut yüzey şeklini alarak emniyetli bağlama yapar.

Product Nr. 2070 Side Press Body

- With its articulated design, it makes safe bonding even on uneven surfaces by taking the existing surface shape.





Yandan Bağlama Dayama

Referans Nr.		
2070-MD702114	14	0.65
2070-MD702116	16	0.65
2070-MD702118	18	0.65
2070-MD702120	20	0.65

Ürün Nr. 2070 Yandan Bağlama Dayama

Product Nr. 2070 Side Press Stopper



Referans Nr.		Sıkma Kuvveti Clamping Force	Nm	
2070-MBS801114	14	2500	60	6.15
2070-MBS801116	16	2500	60	6.15
2070-MBS801118	18	2500	60	6.15
2070-MBS801120	20	2500	60	6.15

Ürün Nr. 2070 Yandan Bağlama (Paralelli) Set

- Mafsallı tasarımıyla düz olmayan yüzeylerde dahi mevcut yüzey şeklini alarak emniyetli bağlama yapar.

Product Nr. 2070 Side Wrench Set (With Parallel)

- With its articulated design, it makes safe bonding even on uneven surfaces by taking the existing surface shape.

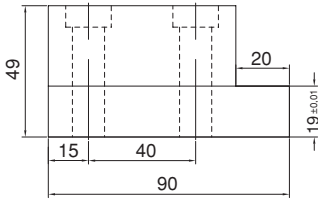

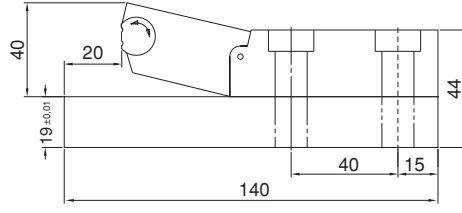

Genişlik / Width 40 mm.

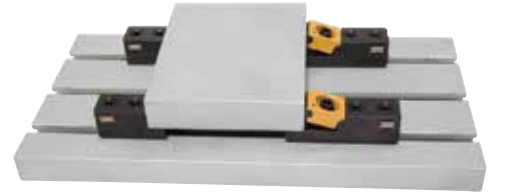

Genişlik / Width 40 mm.



Referans Nr.		
2070-MS801214	14	1.86
2070-MS801216	16	1.86
2070-MS801218	18	1.86
2070-MS801220	20	1.86

Ürün Nr. 2070 Yandan Bağlama Gövde

- Mafsallı tasarımıyla düz olmayan yüzeylerde dahi mevcut yüzey şeklini alarak emniyetli bağlama yapar.



Product Nr. 2070 Side Press Body

- With its articulated design, it makes safe bonding even on uneven surfaces by taking the existing surface shape.

Yandan Bağlama Gövde

Side Press Body



Referans Nr.		
2070-MD802214	14	1.18
2070-MD802216	16	1.18
2070-MD802218	18	1.18
2070-MD802220	20	1.18



Ürün Nr. 2070 Yandan Bağlama Dayama

Product Nr. 2070 Side Press Stopper

Yandan Bağlama Dayama

Side Press Stopper



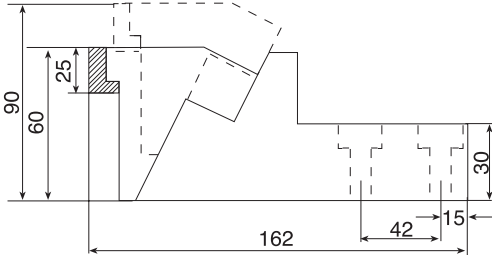

Referans Nr.		Sıkma Kuvveti Clamping Force	Nm	
2105-MYB404114	14	3000	55	2.80
2105-MYB404116	16	3000	55	2.80
2105-MYB404118	18	3000	55	2.80
2105-MYB404120	20	3000	55	2.80
2105-MYB404122	22	3000	55	2.80
2105-MYB404124	24	3000	55	2.80

Ürün Nr. 2105 Blok Yandan Bağlama
Product Nr. 2105 Block Side Press



Genişlik / Width 54 mm.



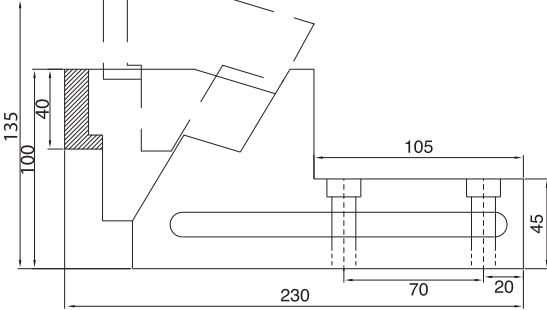

Referans Nr.		Sıkma Kuvveti Clamping Force	Nm	
2105-MYB901120	20	3000	55	6.85
2105-MYB901122	22	3000	55	6.85
2105-MYB901124	24	3000	55	6.85
2105-MYB901128	28	3000	55	6.85

Ürün Nr. 2105 Blok Yandan Bağlama
Product Nr. 2105 Block Side Press



Genişlik / Width 68 mm.



Referans Nr.		Sıkma Kuvveti Clamping Force	Nm	
2105-MYB303114	14	3000	55	2.80
2105-MYB303116	16	3000	55	2.80
2105-MYB303118	18	3000	55	2.80
2105-MYB303120	20	3000	55	2.80
2105-MYB303122	22	3000	55	2.80
2105-MYB303124	24	3000	55	2.80

Ürün Nr. 2105 Blok Yandan Bağlama
Product Nr. 2105 Block Side Press

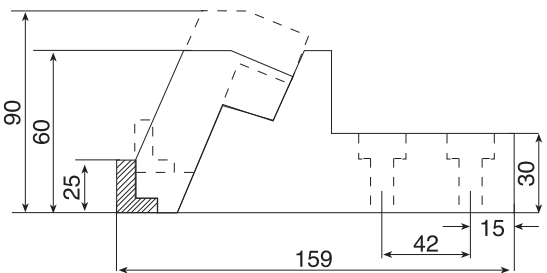

Genişlik / Width 54 mm.



Referans Nr.	a	(kg)
2105-MD404214	14	1.86
2105-MD404216	16	1.86
2105-MD404218	18	1.86
2105-MD404220	20	1.86
2105-MD404222	22	1.86
2105-MD404224	24	1.86

Ürün Nr. 2105 Blok Yandan Bağlama Dayaması
Product Nr. 2105 Block Stopper Side Press

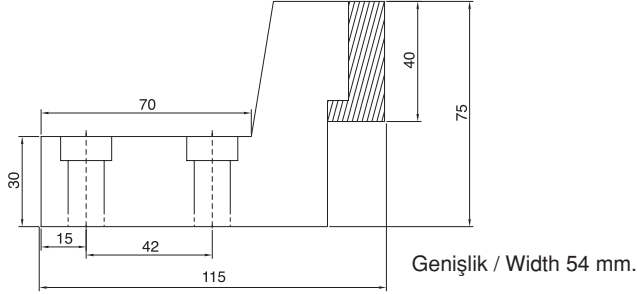

Blok Yandan Bağlama Dayaması

Block Stopper Side Press



Referans Nr.	a	(kg)
2105-MD902120	20	4.50
2105-MD902122	22	4.50
2105-MD902124	24	4.50
2105-MD902128	28	4.50

Ürün Nr. 2105 Blok Yandan Bağlama Dayaması
Product Nr. 2105 Block Stopper Side Press

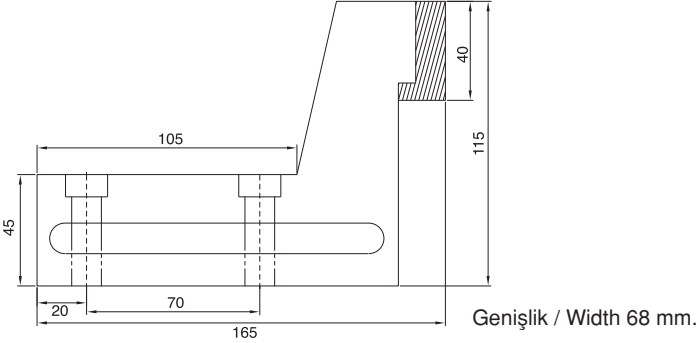

Blok Yandan Bağlama Dayaması

Block Stopper Side Press



Referans Nr.	a	(kg)
2105-MD303214	14	1.17
2105-MD303216	16	1.17
2105-MD303218	18	1.17
2105-MD303220	20	1.17
2105-MD303222	22	1.17
2105-MD303224	24	1.17

Ürün Nr. 2105 Blok Yandan Bağlama Dayaması
Product Nr. 2105 Block Stopper Side Press

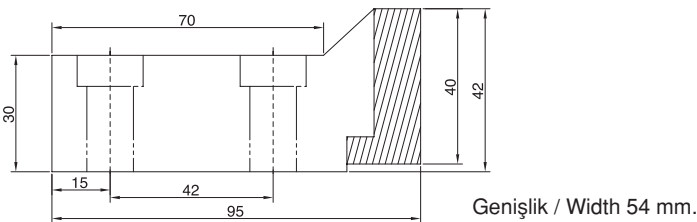

Blok Yandan Bağlama Dayaması

Block Stopper Side Press



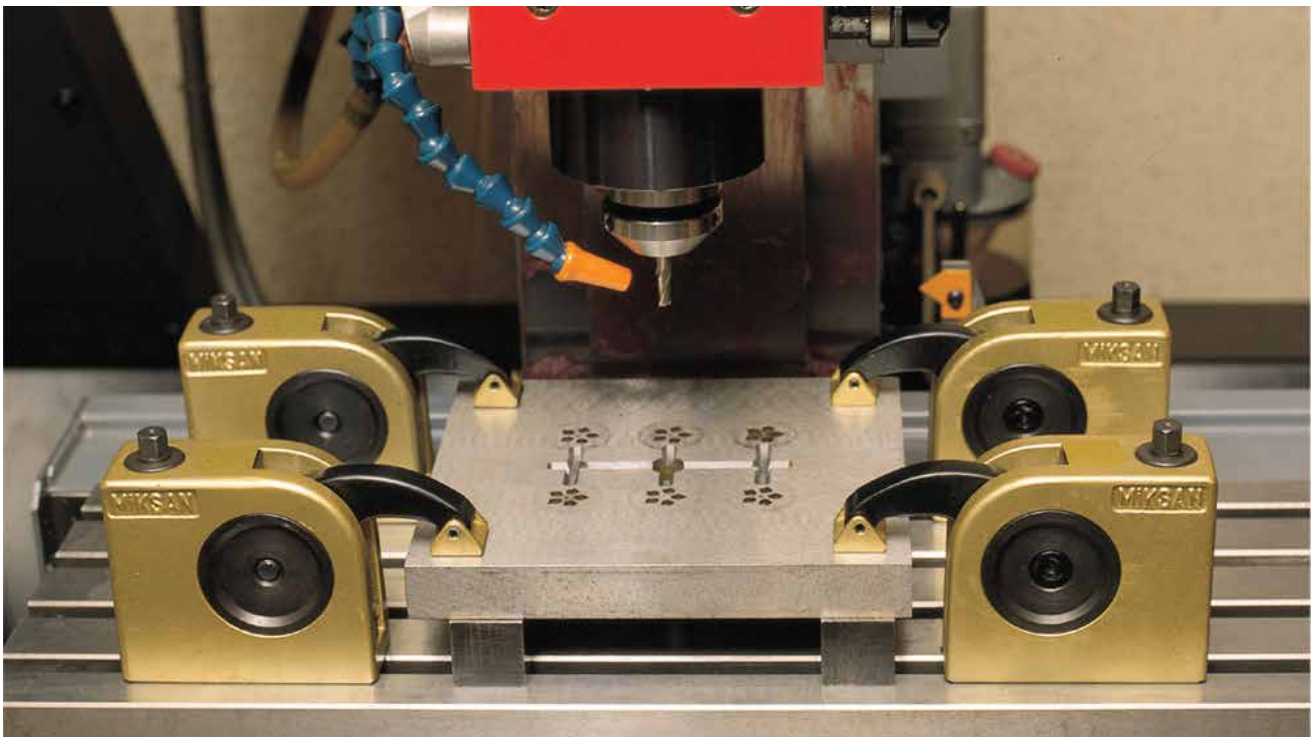
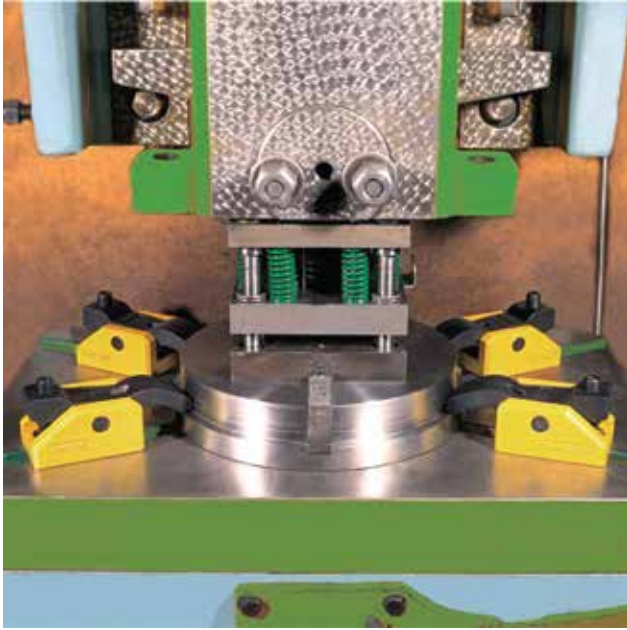



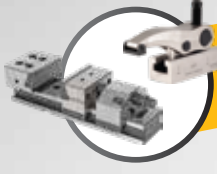

Standart Ürünler
Standard Products



Hidrolik Komponentler
Hydraulic Components



5-Eksen Blok Bağlama Sistemi
5-Axis Clamping Block System



Proje Bazlı Fikstür Uygulamaları
Project Based Fixture Applications



Hızlı Kalıp Değişirme Sistemi
Quick Mold Change System



MIKSAN Hızlı Bağlantı Sistemleri
MIKSAN Quick Clamping Systems



ER-EL Zero Sistem
ER-EL Zero Point Clamping System

Bağlama ekipmanlarında kalite üretiyoruz..

"We produce quality in clamping equipment"

35'i aşkın ülkeye ihracat yapıyoruz...
We export to more than 35 countries



ER-EL®

ER-EL MAKİNA YEDEK PARÇA İML. SAN. VE TİC. LTD. ŞTİ.

Çerkeşli OSB Mah. İMES 3 Blv. No: 14 Dilovası - Kocaeli

Tel: +90 262 502 11 60 Pbx Fax: +90 262 502 11 59

info@er-el.com.tr www.er-el.com.tr



erelkalip
miksanc.clamp



ERELkalip
ClampMiksan



erelkalip
miksanc_clamp



erelkalip
miksancclamp



er-el-kalip
miksanc-clamp

