



Bağlama Ekipmanlarında Kalite Üretiyoruz..  
We produce quality in clamping equipment..  
Wir produzieren qualität in der spanntechnik..

# KALIP YÜKLEME TABLASI

Mold Transport Tray  
Werkzeugwechselwagen



# Kalıp Yükleme Tablası

**TR** Kalıp arabasına veya forklift araçlarına montaj özelliği ile birlikte kolaylıkla sabitlenip kullanılabilir.



## Mold Transport Tray

**EN** It can be mounted on mold cart or forklifts and can be easily used.

## Werkzeugtransportplatte

**DE** Sie kann auf Werkzeugwagen oder Gabelstaplern montiert werden und ist einfach zu bedienen.

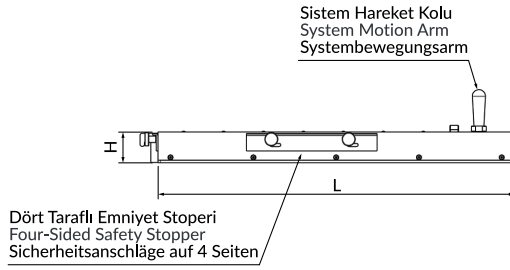

Referans Nr. Order No Referenz Nr.	A	L2	H	L	Kapasite Capacity Kapazität
1024-500670	500	670	71	1015	1 Ton 1Tonne

Taşıma Arabası ve Benzer Ekipmanlar İçin Montaj Delikleri  
Mounting Holes For Transport Tray and Similar Equipment  
Montagelöcher für Transportwagen oder ähnliche Systeme

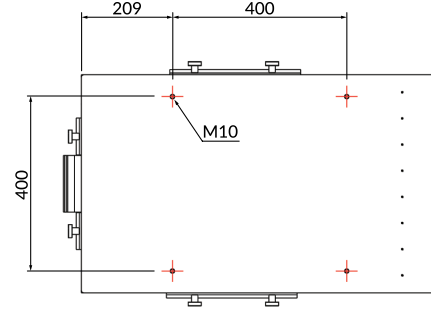
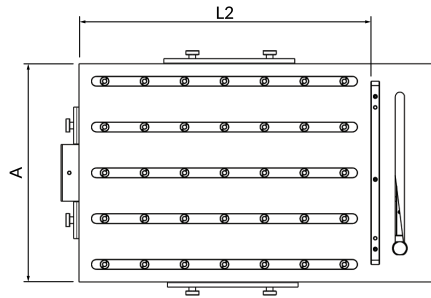

## Kalıp Yükleme Tablası Uygulamaları / Mold Transport Tray Applications / Anwendungsbeispiele für Werkzeugwechselwagen

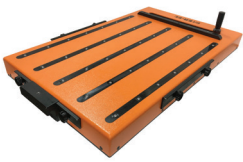

Kalıp Yükleme Tablası  
Mold Transport Tray  
Werkzeugtransportplatte



Kalıp Yükleme Tablası (Araba)  
Mold Transport Tray (Trolley)  
Werkzeugwechselwagen



Kalıp Yükleme Tablası (Elektrikli Forklift)  
Mold Transport Tray (Electric Forklift)  
Elektrischer Werkzeugwechselwagen



Kalıp Yükleme Tablası (Forklift)  
Mold Transport Tray (Forklift)  
Werkzeugwechselwagen (Gabelstapler)

# Kalıp Yükleme Tablası (Arabalı)

**TR** Ağırlığı 1 tona kadar olan kalıpları, pres tablasına veya raflara yerleştirmek için yükleme esnasında hareket ettirmek istendiğinde, yüzey temasını azaltır. Böylece rahatlıkla, çok fazla güce ihtiyaç duymadan hızlı ve pratik şekilde kalıbı yükleme olanağı sağlamaktadır.

## Mold Transport Tray (Trolley)

**EN** Molds up to 1 ton weight, it reduces surface contact when it is desired to be moved during loading to be placed on the press table or shelves. Thus, it provides the possibility of loading the mold easily and quickly without the need for much power.



## Werkzeugwechselwagen

**DE** Für Werkzeuge bis zu einem Gewicht von 1 Tonne geeignet. Er reduziert den Oberflächenkontakt, wenn das Werkzeug während der Beladung bewegt werden soll, um auf den Pressentisch oder ins Regal zu platzieren. So bietet es die Möglichkeit, das Werkzeug einfach und schnell ohne großen Kraftaufwand zu beladen.

Referans Nr. Order No Referenz Nr.	A	L2	H (min. - max.)	L	L1	Kapasite Capacity Kapazität
1024-500671	500	670	480 - 1050	818	1015	1 Ton 1 Tonne

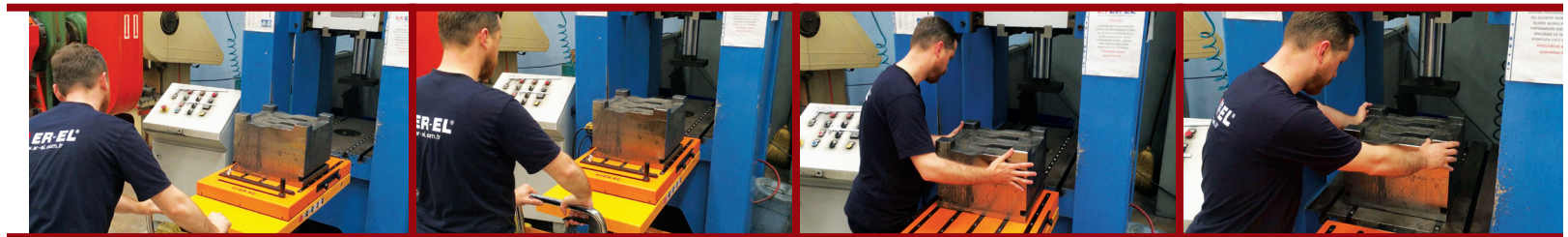
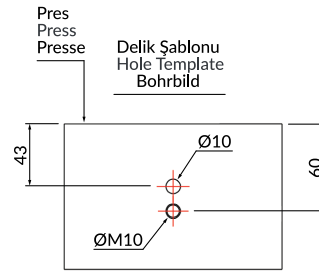
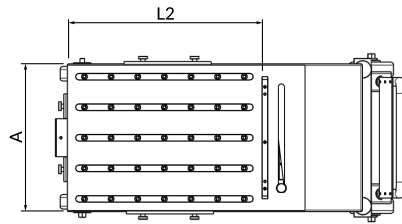
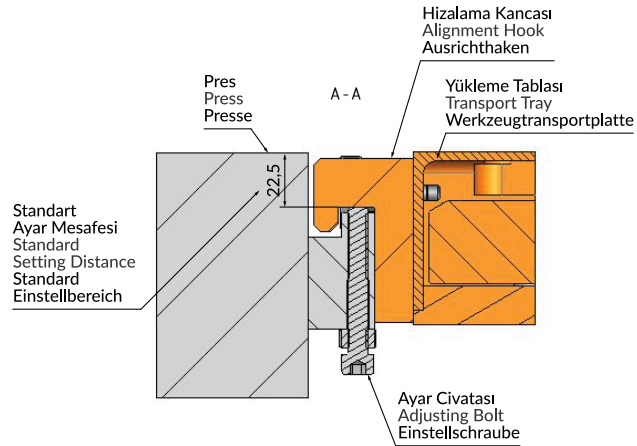
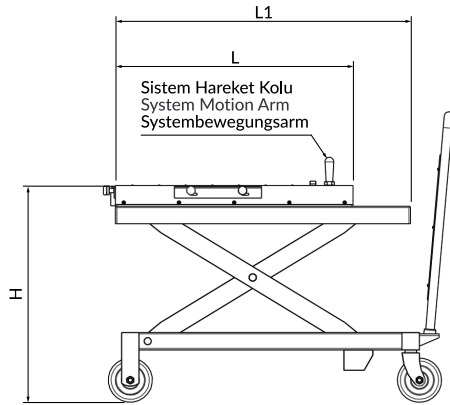

1

2

3

4

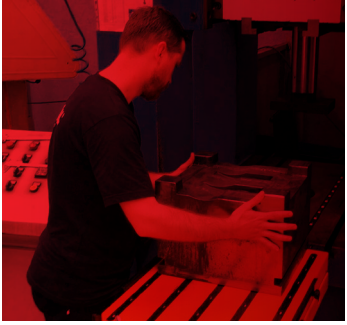

**EM ER-EL®**

**Bağlama Ekipmanlarında Kalite Üretiyoruz..**

*We produce quality in clamping equipment..*

*Wir produzieren qualität in der spanntechnik..*

**Fabrika Adres - Address - Adresse**

Çerkeşli OSB Mah. İMES 3 Blv. No: 14

Dilovası - Kocaeli / TÜRKİYE

Tel / Phone: +90 262 502 11 60

Fax: +90 262 502 11 59

www.er-el.com.tr - info@er-el.com.tr

